

Fusion20

A next-generation RF Fusion™
5G system solution offering:

- Higher levels of integration including Rx LNA and integrated RF shielding
- Reduced sensitivity to environmental impacts
- Faster time to market

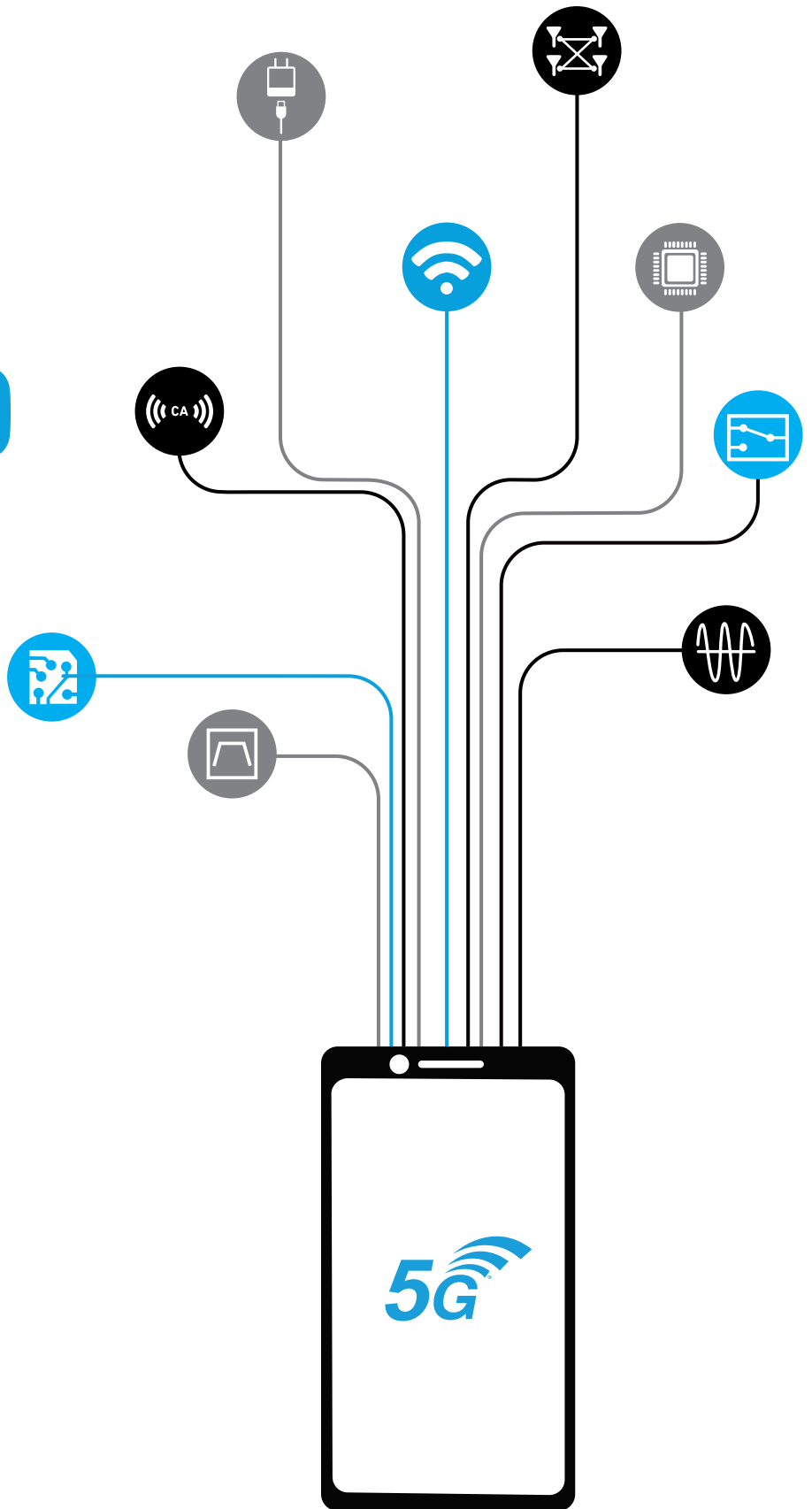

QORVO
all around you

Discover the Fusion20 Solution

Fully Shielded. Fully 5G Capable.

In anticipation of the rapid expansion of 5G terminal devices in today's market, Qorvo has developed the industry's leading integrated RF front-end solution. Drawing on generations of system expertise and leveraging established PA, switch and acoustic filter technology, Fusion20 now reaches a new level of performance and capability. By adding receive LNAs and fully integrated RF shielding, Fusion20 greatly improves connectivity, increases resistance to interference and speeds time to market launch.

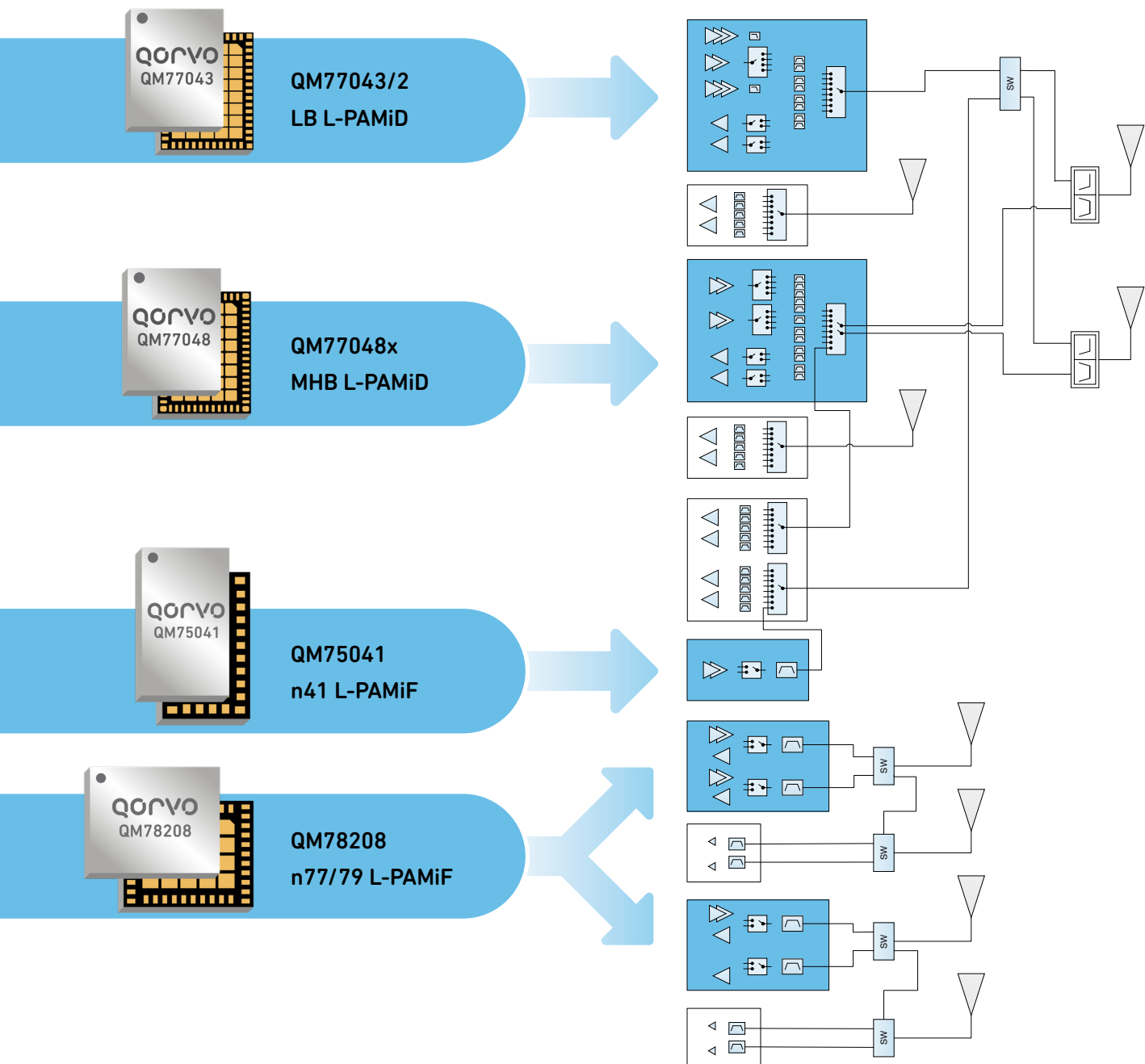

Integration for All Applications

Fusion20 is optimized to provide the right level of integration for all 5G device applications. Whether the application is global or regional, performance or value, Qorvo offers a Fusion20 option to enable high-performance and ease-of-implementation.

Mid-High Band L-PAMiD

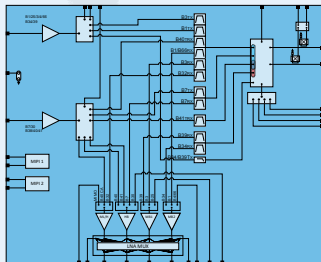

QM77048
Global

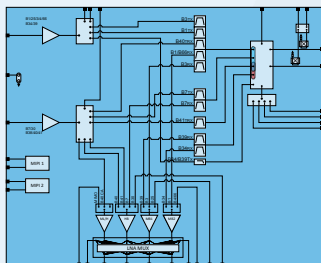

QM77048B
APAC/EU

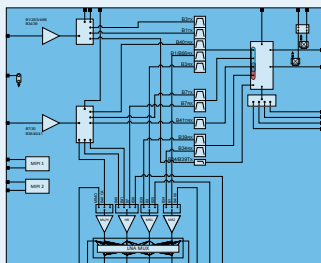

QM77048D
APAC/China

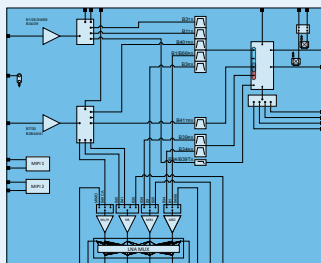

QM77048E
China Domestic

Low Band L-PAMiD

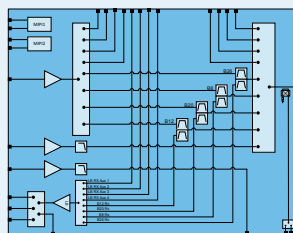

QM77043
APAC/EU

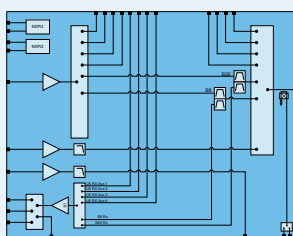

QM77042
APAC/China

Ultra-High Band L-PAMiF

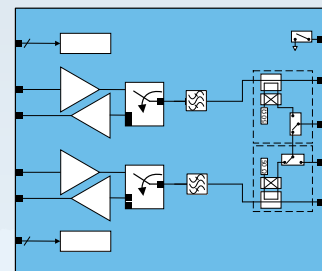

QM78208
n77/n79

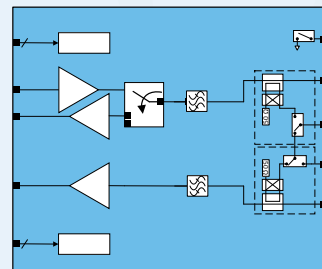

QM78208B
n77/n79(Rx)

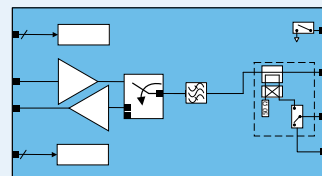

QM78208E n77
QM78207 n77
QM78209 n79

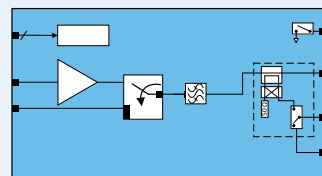

QM75041 n41 qorvo.com

What RF Fusion Can Do For You

Qorvo's product portfolio offers choices for customers looking to optimize their mobile devices for global or regional use. Support for specific bands and features can be selected for any tier of 5G device or for support of any combination of operator spectrum.



MHB P/N	CA 25 /66/30	CA 1+3	CA 39+41	CA 3+41 (160 MHz)	CA 3+40	CA 3+7	CA 1+3+7	CA 1+3+32	NR
QM77048	A	✓	✓	✓ (160 MHz)	✓	✓	✓	✓	1, 25, 3, 4, 7, 40, 41, 66
QM77048B	A	✓	✓	✓ (160 MHz)	✓	✓	✓	X	1, 2, 3, 4, 7, 40, 41, 66
QM77048D	A	✓	✓	✓ (160 MHz)	✓	X	X	X	1, 3, 4, 7, 40, 41
QM77048E	X	✓	✓	✓ (160 MHz)	X	X	X	X	1, 3, 41



LB P/N	2G	n26	n8	n12	n20	n28	n71	AUX
QM77043	✓	✓	✓	✓	✓	A	A	4
QM77042	✓	✓	✓	X	X	A	A	4



UHB P/N	n41	n77/78	n79	200 MHz	PC2
QM78208	X	✓	✓	✓	✓
QM78208B	X	✓	Rx only	✓	✓
QM78207	X	✓	X	✓	✓
QM78209	X	X	✓	X (160 MHz)	✓
QM75041	✓	X	X	N/A	✓

✓ = Optimized for best performance

S = Supported

A = Requires external components

X = Not supported