

Blueprint for 3 GHz, 25 Gbps DOCSIS®

Getting 25 Gbps PON-Like Performance Out of HFC

A Technical Paper prepared for SCTE•ISBE by

John T Chapman

CTO Cable Access and Fellow
Cisco Systems
3700 Cisco Way, San Jose, CA 95134
408-526-7651
jchapman@cisco.com

Hang Jin

Distinguished Engineer
Cisco Systems
3700 Cisco Way, San Jose, CA 95134

Thushara Hewavithana

Senior Architect, Connected Home Division
Intel Corporation
5000 West Chandler Blvd, Chandler, AZ 85226
602-245-1468
thushara.hewavithana@intel.com

Rainer Hillermeier

General Manager Design and Operations Qorvo Germany
Qorvo
Loeffelholzstrasse 20, 90441 Nuremberg, Germany
+49-911-9411-167
Rainer.Hillermeier@qorvo.com

Table of Contents

| Title | Page Number |
|--|-------------|
| Table of Contents | 2 |
| Introduction | 5 |
| Concept..... | 5 |
| 1. The Laws of Physics vs the Needs of the Market..... | 5 |
| 2. Theorem 1: Three technical levers - power, bit loading and distance | 5 |
| 3. Theorem 2: Coax lengths | 6 |
| 4. 3 GHz ESD with Distributed Power Amplification | 7 |
| Spectrum Plans for 3 GHz ESD | 8 |
| 5. Methodology | 8 |
| 5.1. Transition Bands | 8 |
| 5.2. Coexistence with MoCA..... | 8 |
| 5.3. Coexistence with Other RF signals | 10 |
| 5.4. Simplified Bandwidth Accounting | 11 |
| 5.5. Rigorous Bandwidth Accounting | 12 |
| 6. 3 GHz Premium Plan with a 1218 MHz Cross-over with 10 Gbps US..... | 14 |
| 7. 3 GHz MoCA Plan with a 1100 MHz Cross-over | 16 |
| 8. 3 GHz Legacy Update Plan with a 1002/862/750 MHz Cross-over..... | 17 |
| 9. 3 GHz Low Power Plan with a 684 MHz Cross-over | 18 |
| 10. Comparison with DOCSIS 4.0 with FDX..... | 19 |
| 11. Comparison with DOCSIS 4.0 with 1.8 GHz Extended Spectrum | 20 |
| 12. Summary | 21 |
| 3 GHz Passive Taps..... | 21 |
| 13. 3 GHz Tap specifications | 21 |
| 14. 3 GHz Tap Prototype Test Results | 23 |
| Power Plans | 27 |
| 15. Distributed Power Amplification | 27 |
| 16. Optimization of Transmit Power for Capacity | 30 |
| 16.1. Theoretical Framework | 30 |
| 16.2. Backwards Compatible and Optimal Power allocation | 32 |
| 16.3. Results and Conclusions | 33 |
| DOCSIS PHY Optimizations | 34 |
| 17. Introduction..... | 34 |
| 18. A Systematic Approach to Selecting OFDM Parameters..... | 35 |
| 18.1. Target MER..... | 35 |
| 18.2. Cable Propagation Channel..... | 36 |
| 18.3. Cyclic Prefix for OFDM | 37 |
| 18.4. OFDM Symbol Length | 38 |
| 18.5. OFDM Time variations..... | 39 |
| 19. Conclusion..... | 42 |
| Power Amplifier Circuit Design Development | 43 |
| 20. Output Stage Gain Blocks for HFC Amplifiers and Nodes | 43 |
| 21. 3 GHz Output Stage Gain Block Simulation Model | 44 |
| 22. Conclusion..... | 47 |
| Additional Deployment Considerations..... | 48 |
| Summary..... | 49 |

| | |
|---------------------------------|----|
| Acknowledgements | 49 |
| Abbreviations..... | 50 |
| Bibliography & References | 51 |

List of Figures

| <u>Title</u> | <u>Page Number</u> |
|--|-------------------------------------|
| Figure 1: Three Technical Levers..... | 5 |
| Figure 2: Reference HFC Architecture | 6 |
| Figure 3: 3 GHz ESD with Distributed Amplification..... | 7 |
| Figure 4: MoCA Spectrum for a DOCSIS System..... | 9 |
| Figure 5: 3 GHz Premium Plan | 14 |
| Figure 6: 3 GHz MoCA Plan..... | 16 |
| Figure 7: 3 GHz Legacy Plan..... | 17 |
| Figure 8: 3 GHz Low Power Plan | 18 |
| Figure 9: Frequency Plan with Extended FDX..... | 19 |
| Figure 10: 1.8 GHz Static FDX Frequency Baseline | 20 |
| Figure 11: 3 GHz tap prototype..... | 23 |
| Figure 12: Test data for Tap14 insertion loss | 24 |
| Figure 13: Test data for Tap14 tap loss..... | 24 |
| Figure 14: Test data for Tap20 insertion loss | 25 |
| Figure 15: Test data for Tap20 tap loss..... | 25 |
| Figure 16: Test data for Tap26 insertion loss | 26 |
| Figure 17: Test data for Tap26 tap loss..... | 26 |
| Figure 18: The spectrum partition | 28 |
| Figure 19: Hybrid Active Tap..... | 28 |
| Figure 20: HAT block diagram | 29 |
| Figure 21: Simulation results of total AC power consumption vs number of amplifiers for N+2 network... 29 | 29 |
| Figure 22: PA nonlinear distortion characterisation (source: Qorvo 3 GHz PA simulation data)..... | 31 |
| Figure 23: Optimal Power Allocation for backwards compatible 3 GHz ESD..... | 33 |
| Figure 24: Comcast Model I..... | 33 |
| Figure 25: Capacity with and w/o transmit power optimization..... | Error! Bookmark not defined. |
| Figure 26: Optimized SNR (solid) and SNR achieved with flat transmit PSD (dashed)..... | 35 |
| Figure 27: Cyclic Prefix Overhead..... | 38 |
| Figure 28: CMTS Phase Noise PSD – DSB, referred to 1218 MHz..... | 41 |
| Figure 29: Efficiency Development of Output Stage Gain Blocks in so-called Power Doublers..... | 43 |
| Figure 30: Simplified model schematic of balanced design in cascode configuration employing GaAs semiconductor technology for FET1 and FET2 and GaN for FET3 and FET4..... | 44 |
| Figure 31: Multi-carrier distortion simulation test bench..... | 45 |
| Figure 32: Simulation RF input and output spectrum and the MER per subcarrier over frequency | 46 |
| Figure 34: Simulated compression characteristic of averaged MER versus TCP | 47 |

List of Tables

| Title | Page Number |
|--|--------------------|
| Table 1: DOCSIS 3.1 Downstream Capacity | 12 |
| Table 2: DOCSIS 3.1 Upstream Capacity | 13 |
| Table 3: 3 GHz Premium Plan with Classic FDX | 14 |
| Table 4: 3 GHz Premium Plan with Extended FDX..... | 14 |
| Table 5: 3 GHz MoCA Plan with Classic FDX | 16 |
| Table 6: 3 GHz MoCA Plan with Extended FDX..... | 16 |
| Table 7: 3 GHz Legacy Plan with Classic FDX (Three Variations) | 17 |
| Table 8: 3 GHz Legacy Plan with Extended FDX | 18 |
| Table 9: 3 GHz Low Power Plan with Classic FDX..... | 18 |
| Table 10: 1.218 GHz DOCSIS 4.0 with Classic FDX | 19 |
| Table 11: 1.8 GHz DOCSIS 4.0 with No FDX..... | 20 |
| Table 12: Spectrum Plan Data Capacity Summary..... | 21 |
| Table 13: 3 GHz Tap Specifications..... | 22 |
| Table 14: DOCSIS 3.1 DS Micro-Reflection Bound (mask)..... | 36 |
| Table 15: Coax Cable Losses for 0.5 μ s echo | 36 |
| Table 16: Coax Channel Model at 2 GHz and 3 GHz | 37 |
| Table 17: CMTS RMS Jitter Spec | 39 |
| Table 18: CMTS Phase Noise mask at 1002 MHz..... | 40 |
| Table 19: Combined Phase Noise Mask for CMTS..... | 40 |
| Table 20: ICI/dBc ratio in dB due to CMTS Phase Noise from Figure 28 | 42 |

Introduction

The path to 10 Gbps downstream has been laid out with DOCSIS 3.1 using spectrum up to 1.2 GHz. DOCSIS 4.0 adds full duplex operation for a 5 Gbps upstream or an extended spectrum high-split option using 1.8 GHz. Both support similar 10 Gbps throughputs. Yet, the PON world is already 10 Gbps downstream and upstream, and due to deliver a 25 and 50 Gbps standard in 2020. What will cable’s response be?

The good news is that 25 Gbps DOCSIS can be built on the same wiring infrastructure of 10G DOCSIS 4.0 – the same digital Fiber to the Node, the **trunk** coax to the TAP, and drop coax to the Home. Furthermore, the transition from 10 Gbps speeds to 25 Gbps is not imposing that the fiber need to go any deeper. In DSL, the transition to higher speeds requires taking fiber deeper and making the copper link shorter whereas this is not the case for “25G” DOCSIS.

At the same time, extended spectrum DOCSIS (ESD) will require a complete product family refresh with CMTS/RPD - node - amp - tap - CM which will take time and investments from both vendors and operators. This paper shows how a roadmap to 3 GHz, 25 Gbps ESD is possible with 1.8 GHz ESD as a steppingstone. This paper explains the various techniques to get there and how the transition can be done. Considerations on power consumption, coexistence with FDX, spectrum plans and interference from MoCA, LTE and Wi-Fi are discussed.

Concept

1. The Laws of Physics vs the Needs of the Market

The state of the art for nodes today is the DOCSIS 3.1 FDX N+0 specification with a 54 MHz to 1.218 GHz downstream spectrum with a total composite power (TCP) of 73.8 dBmV and tilt all the way up to 1218 MHz, or 71-72 dBmV with the appropriate stepping down of power for the last channel. To go beyond the 1.218 GHz barrier, something has to give or be changed. First, we start with two fundamental theorems and then lead to a course of action.

2. Theorem 1: Three technical levers - power, bit loading and distance

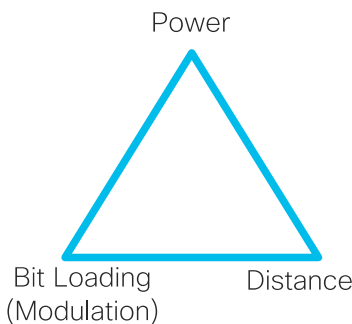

Figure 1: Three Technical Levers

There are three technical “levers” that can be changed, although pushing on one generally means pulling back on the other two. These levers are shown in Figure 1.

The first lever is power. Power is the most popular one. In DOCSIS 3.1, the TCP of the node was pushed farther than it had ever been before and there is not much more room to push it. Depending on the efficiency of the amplifier, this requires more node power. The output power stage of a node is built with Class A power amplifiers (PAs). If a class A amplifier has a 1% efficiency, then a 1 watt output would require 100 watts of power supply source input. Moving that amplifier to 2% efficiency would drop the power supply usage to 50 watts which is a huge difference.

As we will see later in the paper, newer silicon technologies have increased the efficiency of the PA. Technologies like digital pre-distortion (DPD) can correct for some of the non-linearities in the amplifier and allow it to be pushed a bit harder. The combination of all of these techniques is really not enough to expand the frequency range from 1.2 GHz to 1.8 GHz or 3.0 GHz.

The second lever is bit loading. Bit loading refers to how many bits are represented per hertz of bandwidth. It gets more complex in implementation with symbol rates and sub-carriers, each with its own constellation. But, in general, 10 bits per hertz uses $2^{10} = 1024$ -QAM constellation. The ability to support this constellation depends on the difference between power level of the channel (signal) and the corresponding modulation error ratio (MER) which is basically a noise floor. If the power level goes down, say due to greater attenuation at higher frequencies, and the noise floor is flat, the transmission channel will still work but may require a lower modulation. This is the approach that the 1.8 GHz ESD specification is considering.

The third lever is distance. Distance is the space between the node and the first amp and then the distance between amps. Hybrid fiber/coax (HFC) plants are built by using higher-output power nodes; the RF power of the RF signals decreases as the signals travel through the span of cable and taps, until the RF power is so low that it needs to be amplified again. This plant layout is shown in Figure 2. Thus, the span of distance between nodes is dependent on the output power of the nodes and the cable and tap loss. If operation is required at a higher frequency where the cable and tap loss is greater, and the RF power output of the node stays the same, then a shorter distance between nodes and amplifiers is required. The 3 GHz ESD proposal in this paper leverages this principle but does so with an interesting twist.

3. Theorem 2: Coax lengths

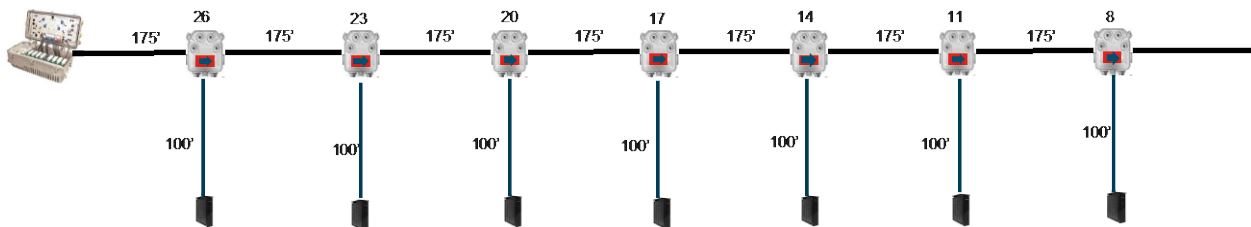

Figure 2: Reference HFC Architecture

The DOCSIS specification [1] assumed maximum one-way transit delay in a cable network is 0.800 ms, which is the equivalent of about 100 miles of single-mode optical fiber. That plant today can run at 1.218 GHz at a modulation of 4K QAM. That's impressive. Of that plant length, though, most of it is the fiber run. The coax plant after the optical node is more on the order of about 5000 feet (1500 m). In fact, with the distributed access architecture (DAA), there is no longer an analog optical distance to consider.

The second theorem here is that there are no 5000 foot coax runs. Instead, the coax plant is made up of a series of very short pieces of coax separated by passives such as taps, and actives such as nodes and amps. As a thought experiment, if we replaced all passive and actives with 3 GHz amps, it would take very little amplification to drive that short piece of coax and the attenuation of that coax would be of little consequence. The frequency limitation would only be based on the quality of the coax. Most of the coax in the plant should be 3 GHz capable unless it has physical defect or is otherwise damaged.

4. 3 GHz ESD with Distributed Power Amplification

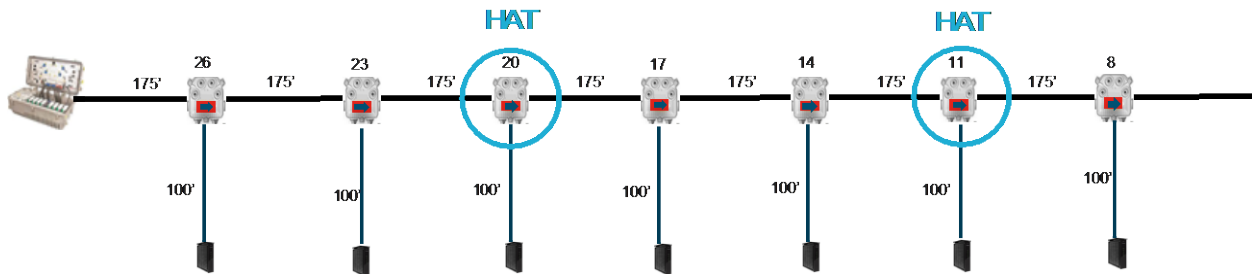

Figure 3: 3 GHz ESD with Distributed Amplification

If we combine these two concepts together, we have the answer, but with a twist. The twist is that there are two loss plans that are used, not one. The first loss plan is the one that already exists that has set the deployed spacing of the nodes and amplifiers. The second loss plan is the new high frequency loss plan. They both exist at the same time and the new high loss plan can be designed almost independent of the current loss plan.

Let's assume for now we limit the lower frequency loss plan up to 1002 MHz which is a common deployed maximum downstream frequency today. Then for the new loss plan from the 1002 MHz to 3000 MHz, we introduce small extended spectrum amplifiers (ESA) in the cable span between the established nodes and amplifiers. We are referring to this system as distributed power amplification (DPA).

It turns out that we do not have to put a lot of these ESAs between the larger amplifiers. Two or three per span should be sufficient. They could be co-located beside a tap or even within a tap housing. If they are within a tap housing, we are referring to that as a hybrid-active tap (HAT). If the ESA were to die, only the extended spectrum would be impacted, so the plant would continue to work but at diminished capacity.

We can also choose a lower power ESA by just defining more amps. The loss plan of the higher frequencies can be rebalanced independent of the lower loss plan. Also, as we will see in Section 15 on Distributed Power Amplification, that by changing the separation frequency between the higher band and the lower band, we can change the overall power consumption and efficiency of the HFC network.

We discuss these principles in subsequent sections. But first, let's do some spectrum planning and look at what other factors might influence the choice of the boundary between the lower and upper bands.

Spectrum Plans for 3 GHz ESD

There are a variety of spectrum plans that could be chosen, depending upon the legacy frequency plan of the plant, what the spectrum is used for and how much power needs to be saved. These spectrum plans also show operation with and without FDX DOCSIS.

5. Methodology

5.1. Transition Bands

In the 3 GHz extended spectrum approach described in this paper, there is an extended spectrum transition band (ETB) required between the lower legacy and upper ESD spectrum plans for several reasons. This is explained in more detail in Section 15 and summarized here.

1. The ETB requirement is due to a diplexer that is located in the in-line amplifiers between the high and low frequencies. In this approach, the size of the ETB is set to the same size as the FDX transition band (FTB) which is 17.5% of the lower frequency of the transition band. This is described in Section 15.
2. The power level between the last carrier in the lower frequency band and the first carrier in the upper band may be different. This means the out-of-band spurious noise from the higher power carrier might impact the lower power carrier. This is described in Section 15.
3. There is a transition band at the top of the FDX band for FDX CMs and this transition band may or may not line up with the other two transition bands. For current FDX DOCSIS, this transition band is 17.5% and extends from 684 MHz to 804 MHz [4].

Part of the art of frequency planning is to maximize usage of the ETB if possible with some other services such as video, legacy DOCSIS, MoCA or other transition bands.

5.2. Coexistence with MoCA

Multimedia over Coax Alliance (MoCA) is a technology that provides Ethernet over coax within the residential environment. It is possible to physically isolate MoCA and DOCSIS within a home at installation time. When the drop cable terminates at the house, it would hit a two-way splitter. One leg of that splitter would go to the DOCSIS CM. The other leg of that splitter would go through a MoCA filter and then to the rest of the residential network. Note that this approach supports legacy STB MoCA network but would not support Wi-Fi extension ports from the CM over MoCA.

Unfortunately, many homes do not have a MoCA filter and thus the DOCSIS spectrum and the MoCA spectrum above 1 GHz may mutually interfere with each other. In this section, we describe an approach to manage that interference. But first, some background on MoCA.

MoCA 1.1 Band D is 400 MHz wide and extends from 1125 MHz to 1525 MHz. 50 MHz MoCA 1.1 channels can be placed starting at 1125 MHz in 50 MHz increments. MoCA 2.0 Band D is 550 MHz wide and extends from 1125 MHz to 1675 MHz. A single 100 MHz MoCA 2.0 channel can be placed starting at 1125 in 25 MHz steps. MoCA 2.0 also has a dual bonded channel that occupies 225 MHz.

MoCA 1.1/2.0 requires a 125 MHz guard band between adjacent unassociated MoCA channels. The SCTE 235 2017 operational practice [2] requires a 25 MHz guard band between any MoCA spectrum and DOCSIS spectrum, although Figure 2-7 in the MoCA 2.0/2.5 RF specification [3] would prefer more like 57 MHz or 81 MHz.

The idea here is to open up some spectrum and steer MoCA into it. In theory, that spectrum gap could also contain a separate DOCSIS 3.1 channel of which there is a selective membership that never interferes with MoCA on the plant, but that is an advanced algorithm not considered in this paper's bandwidth calculations.

There are several schemes that could be used. Some of these approaches starting at the lowest frequencies permitted are shown in Figure 4.

- (a) Single channel: This will support either one MoCA 1.1 channel with 100 MHz total bandwidth, or one MoCA 2.0 channel with 150 MHz total bandwidth (signal plus guard bands). This may be quite practical if most homes have only one common MoCA channel. This approach is used in Section 0.
- (b) Single channel: Similar to (a) but the DOCSIS guard bands have been increased to 75 MHz for MoCA 1.1 and 50 MHz for MoCA 2.0. This is more in line with the MoCA 2.0/2.5 RF spec co-existence examples [3]. This approach is described in Section 0.
- (c) Single channel: Similar to (b) but shifted by 100 MHz. This approach is described in Section 0.
- (d) Dual channel: The MOCA 2.0 specification requires 125 MHz between two unrelated MoCA channels. This mode is described in Section 10.

(a) Single Channel with MOCA 1.1 or 2.0 at lowest frequencies

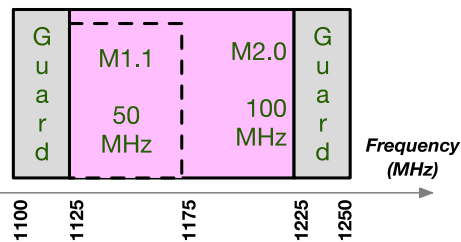

(b) Single Channel with MOCA 1.1 or 2.0 at 1100 MHz

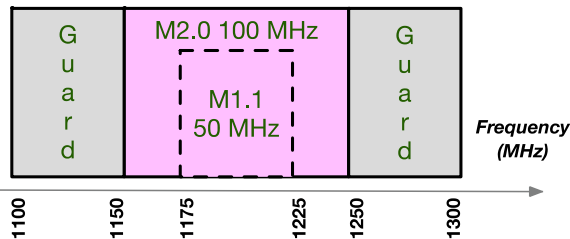

(c) Single Channel with MOCA 1.1 or 2.0 at 1218 MHz

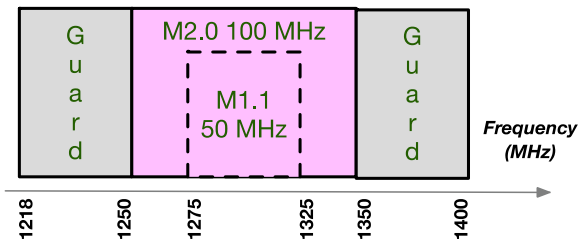

(d) Dual Channel MOCA 1.1 and 2.0 at 1100 MHz

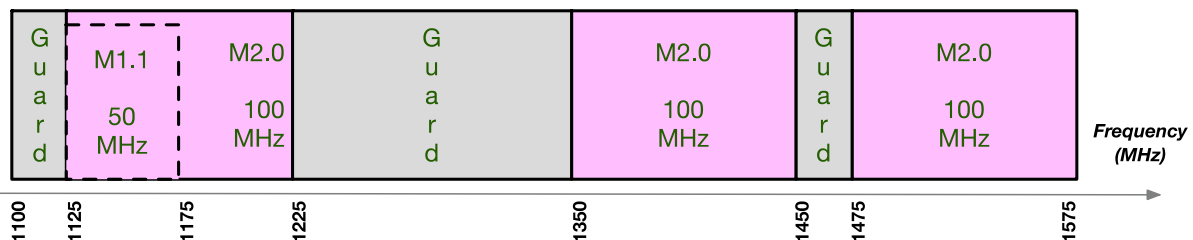

Figure 4: MoCA Spectrum for a DOCSIS System

In 2019, MoCA 2.5 was released. MoCA 2.5 supports bonding across five directly adjacent 100 MHz channels with a maximum throughput of 2.5 Gbps in the same extended Band D. MoCA 2.5 could exist above the 1218 MHz legacy spectrum but severely impacts a 1.8 GHz extended spectrum frequency plan.

This white paper includes MOCA interference in its spectrum recommendations.

5.3. Coexistence with Other RF signals

With any new spectrum allocation comes previous tenants in the form of other spectrum. There are two fundamental ways that the old tenants and the new tenants do not get along:

1. Signal ingress when RF energy exterior to the coax plant comes into the plant and interferes with the cable signal.
2. Signal leakage (signal egress) where the RF energy from the HFC escapes and interferes with external RF spectrum.

In theory, the HFC plant is shielded and there is a high isolation between the two spaces. In practice, all it takes is a loose F connector somewhere. The challenge here, though, is that a defect in the coax plant that does not create ingress or leakage below 1 GHz may for plant that go up to 1.8 or 3.0 GHz.

Let's look at a few culprits. The problem can be split into three frequency zones of interest.

Below 1218 MHz:

In the over-the-air environment, there are all kinds of signal allocations that represent potential sources of ingress and direct pickup interference. Among them are UHF TV broadcast (470 MHz to 698 MHz), LTE (698 MHz to 806 MHz), various cellular and trunked radio services in the 800 MHz band, ISM in the 902 MHz to 928 MHz band, amateur radio service in the 420 MHz to 450 MHz range (as well as shared operation in the 902 MHz to 928 MHz ISM band). UHF broadcast TV services in the 600 MHz spectrum (just below the current LTE band) are in the process of being relocated to lower frequencies, as new mobile services begin operation there. And don't forget TV, FM broadcast, two-way radio, etc., below 470 MHz.

The 600 MHz spectrum has been auctioned off, and there is a multi-year transition period underway in which UHF TV broadcasters are vacating the 600 MHz spectrum (moving to lower frequencies). This transition is supposed to be complete in 2020. As such, in addition to the 698 MHz to 806 MHz LTE band, there will be new non-broadcast LTE-like services operating below 698 MHz that will be potential sources of ingress interference and susceptible to cable network leakage.

It is worth noting that with good due diligence and a lot of measurements, the HFC plant works despite this interference.

From 1218 MHz to 1794 MHz:

In the over-the-air spectrum one will find more LTE and cellular operation; GPS (not likely to cause interference to cable services, but could be interfered with by leakage from a cable network); amateur radio in the 1240 MHz to 1300 MHz spectrum (keep in mind that U.S. ham operators are allowed up to 1500 watts PEP transmitter power); and more mobile (cellular, etc.) services.

From 1794 MHz to 3 GHz:

One can find more mobile services, Wi-Fi, amateur radio, broadcast studio links (point-to-point), microwave ovens (2.45 GHz), and so on. Wi-Fi is probably the biggest challenge as it will co-exist with DOCSIS within the home gateway. Wi-Fi (801.11b/g/n/ax) in North America is from 2.401 MHz to 2.483 MHz. Zigbee and Bluetooth also share these frequencies.

This whitepaper notes this interference for further study.

5.4. Simplified Bandwidth Accounting

To keep bandwidth calculations in the following section simple but reasonably accurate, the downstream is calculated with 4K QAM (12 bits/Hz) at 80% efficiency, so 9.6 bits/symbol/Hz net. The upstream is calculated at 1K QAM (10 bits/symbol/Hz) with 80% efficiency, so 8 bits/Hz net. The results are approximate and rounded off for readability.

DOCSIS 3.1 OFDM downstream channels are 192 MHz maximum width and DOCSIS 3.1 OFDMA upstream channels are 96 MHz maximum width. Fractional OFDM channels are quoted for simplicity, but in reality, may be a combination of OFDM and SC-QAM. Also, the final frequency assignments may differ slightly from what is in this paper depending upon final channelization choices.

It should also be noted that legacy video in the downstream will reduce the spectrum available for DOCSIS and thus DOCSIS will have a lower throughput when video carriers are present. Also, if a 3 GHz DAA node is fed with 25 Gbps fiber, operation beyond 25 Gbps is not relevant.

5.5. Rigorous Bandwidth Accounting

Here is the detailed version and how the 20% overhead was observed. The results are close to the same.

Table 1: DOCSIS 3.1 Downstream Capacity

| Downstream | | | |
|---------------------------------------|-------------|-------------|-------------|
| BW | 192 | 192 | MHz |
| Guardband | 2 | 2 | |
| FFT size (4K or 8K FFT) | 4096 | 8192 | subcarriers |
| Subcarrier spacing | 50 | 25 | kHz |
| FFT duration (useful symbol duration) | 20 | 40 | μs |
| Cyclic prefix (CP) | 1.25 | 1.25 | μs |
| Effective symbol duration | 21.25 | 41.25 | μs |
| Number of active subcarriers | 3800 | 7600 | subcarriers |
| Pilot overhead | 30 | 60 | |
| PLC overhead (number of subcarriers) | 8 | 16 | subcarriers |
| Num of NCP | 10 | 10 | |
| QAM order of NCP | 4 | 4 | |
| NCP overhead | 120 | 120 | |
| FEC overhead | 12% | 12% | |
| Data QAM order (bits per symbol) | 12 | 12 | |
| | | | |
| Total data bit | 38351 | 77966 | |
| L1 Throughput (Gbps) | 1.80 | 1.89 | Gbps |
| Efficiency | 78% | 82% | |
| Equivalent bits/Hz | 9.4 | 9.8 | |

Table 2: DOCSIS 3.1 Upstream Capacity

| Upstream | | | |
|---------------------------------------|-------------|-------------|-------------|
| BW | 96 | 96 | MHz |
| Guardband | 1 | 1 | |
| FFT size (2K or 4K FFT) | 2048 | 4096 | subcarriers |
| Subcarrier spacing | 50 | 25 | kHz |
| FFT duration (useful symbol duration) | 20 | 40 | μs |
| Cyclic prefix (CP) | 1.25 | 1.25 | μs |
| Effective symbol duration | 21.25 | 41.25 | μs |
| Number of active subcarriers | 1900 | 3800 | subcarriers |
| Frame length | 18 | 9 | |
| Mini-slot height | 8 | 16 | |
| Pilot pattern | 2 | 2 | |
| Pilot overhead | 4% | 4% | |
| FEC overhead | 11% | 11% | |
| | | | |
| Data QAM order (bits per symbol) | 10 | 10 | |
| | | | |
| Total data bit | 16185 | 32370 | |
| Throughput (Gbps) | 0.76 | 0.78 | Gbps |
| Efficiency | 79% | 82% | |
| Equivalent bits/Hz | 7.9 | 8.2 | |

6. 3 GHz Premium Plan with a 1218 MHz Cross-over with 10 Gbps US

If the goal is to get to a 10 Gbps upstream, then lots of upstream spectrum will be needed, and that spectrum should be at the lowest frequency possible so that the minimum power will be required to drive it. Figure 5 shows a 3 GHz frequency plan where the cross-over between the legacy spectrum and the extended spectrum starts at 1218 MHz.

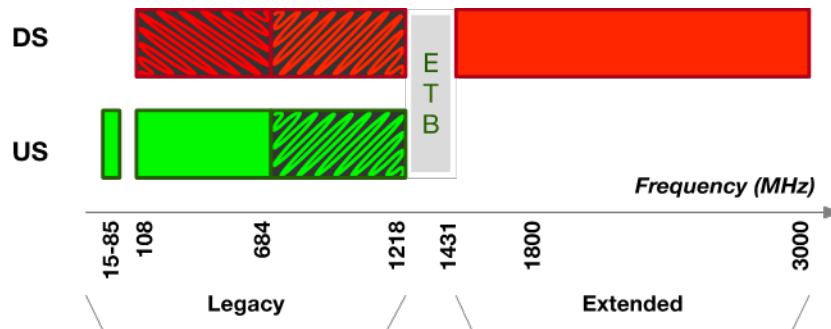

Figure 5: 3 GHz Premium Plan

The current HFC equipment is designed to go to 1218 MHz, although in practice, most deployed HFC plants only have spectrum plans to 1002 MHz or less. The ETB in this approach is placed at 1218 MHz.

Let's do the numbers.

Table 3: 3 GHz Premium Plan with Classic FDX

| Freq Range MHz | Comments | US Gbps | DS no FDX Gbps | DS with FDX Gbps |
|----------------------------|-----------------------------|----------|----------------|------------------|
| 15 to 85 | 70 MHz, 4 ATMDA + 0.5 OFDMA | 0.5 | | |
| 108 to 684 | 576 MHz, 6 OFDMA, 3 OFDM | 4.5 | | 5.5 |
| 684 to 1218 | 534 MHz, 2.8 OFDM | | 5 | 5 |
| 1431 to 3000 | 1569 MHz, 8.2 OFDM | | 15 | 15 |
| Total Data Capacity | | 5 | 20 | 25 |

In Table 3, with a 684 MHz return path, the upstream data capacity is 5 Gbps. The downstream data capacity is 25 Gbps with FDX enabled and 20 Gbps with FDX not enabled.

Table 4: 3 GHz Premium Plan with Extended FDX

| Freq Range MHz | Comments | US Gbps | DS no FDX Gbps | DS with FDX Gbps |
|----------------------------|------------------------------|------------|----------------|------------------|
| 15 to 85 | 70 MHz, 4 ATMDA + 0.5 OFDMA | 0.5 | | |
| 108 to 684 | 576 MHz, 6 OFDMA, 3 OFDM | 4.5 | | 5.5 |
| 684 to 1218 | 534 MHz, 5.6 OFDMA, 2.8 OFDM | 4.3 | | 5 |
| 1431 to 3000 | 1569 MHz, 8.2 OFDM | | 15 | 15 |
| Total Data Capacity | | 9.3 | 15 | 25 |

In Table 4, an extended FDX upstream path, one that has not been defined yet in the standards, is presumed. In this example, the return path is the full 15 MHz to 1218 MHz (omitting 85 MHz to 108

MHz). The upstream data capacity with 1K QAM is 9.3 Gbps. The downstream data capacity is 25 Gbps with FDX and 15 Gbps without FDX.

The 9.6 Gbps upstream is very impressive, but it is not quite 10 Gbps. There are several refinements that can provide 10 Gbps upstream:

1. If the US were run at 2K QAM which provides 10% more data capacity (currently required at the CM but not at the CMTS), the upstream throughput would increase to ≈ 10.3 Gbps.
2. If the US were taken to 1300 MHz with 1K QAM, it would provide 10 Gbps.
3. If the upstream were taken to 1260 MHz, that would exactly be 12 OFDMA channels and 9.7 Gbps, which is a convenient design point and should be close enough to 10 Gbps.
4. If bonding across ATDMA legacy is a problem, and a 10 Gbps upstream service is all above 108 MHz, then 13 OFDMA channels would be needed which would push the return path upper bound to 1356 MHz.

The advantage of this approach is that it would allow for growth of the upstream plant to go to 10 Gbps. The ETB should be usable for MoCA co-existence using Figure 4 option (c), but is not usable for legacy MPEG-TS video. The ETB would also provide the FDX transition band for the extended FDX CMs. Also, if the ESA failed, the passive path that would remain would contain the entire 1218 MHz spectrum.

The disadvantage of this plan is that it uses maximum power. There is the maximum TCP that is already used for the legacy plan and then there is the additional power required for the extended spectrum. Of course, if the power is there, then this plan provides the most upstream spectrum with MoCA protection.

Note that at this time, that there is no extended FDX DOCSIS specification.

7. 3 GHz MoCA Plan with a 1100 MHz Cross-over

This is a 3 GHz frequency plan where the cross-over between the legacy spectrum and the extended spectrum starts at 1100 MHz to facilitate co-existence with MoCA and where some HFC power can be saved. This is shown in Figure 6.

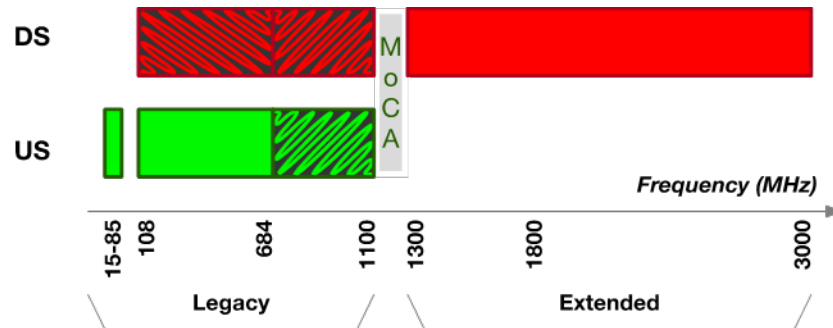

Figure 6: 3 GHz MoCA Plan

Let's do the numbers.

Table 5: 3 GHz MoCA Plan with Classic FDX

| Freq Range MHz | Comments | US Gbps | DS no FDX Gbps | DS with FDX Gbps |
|----------------------------|-----------------------------|----------|----------------|------------------|
| 15 to 85 | 70 MHz, 4 ATMDA + 0.5 OFDMA | 0.5 | | |
| 108 to 684 | 576 MHz, 6 OFDMA, 3 OFDM | 4.5 | | 5.5 |
| 684 to 1100 | 416 MHz, 2.2 OFDM | | 4 | 4 |
| 1300 to 3000 | 1700 MHz, 8.9 OFDM | | 16 | 16 |
| Total Data Capacity | | 5 | 20 | 25 |

In Table 5, with a 684 MHz return path, the upstream data capacity is 5 Gbps. The downstream data capacity is 25 Gbps with FDX enabled and 20 Gbps with FDX not enabled.

Table 6: 3 GHz MoCA Plan with Extended FDX

| Freq Range MHz | Comments | US Gbps | DS no FDX Gbps | DS with FDX Gbps |
|----------------------------|-----------------------------|------------|----------------|------------------|
| 15 to 85 | 70 MHz, 4 ATMDA + 0.5 OFDMA | 0.5 | | |
| 108 to 684 | 576 MHz, 6 OFDMA, 3 OFDM | 4.5 | | 5.5 |
| 684 to 1100 | 416 MHz, 4 OFDMA, 2.2 OFDM | 3.3 | | 4 |
| 1300 to 3000 | 1700 MHz, 8.9 OFDM | | 16 | 16 |
| Total Data Capacity | | 8.4 | 16 | 25 |

In Table 6, an extended FDX upstream path, one that has not been defined yet in the standards, is presumed. In this example, the return path is 1100 MHz. The upstream data capacity is 8.4 Gbps and the downstream data capacity is 25 Gbps with extended FDX enabled and 16 Gbps without extended FDX enabled.

The advantages of this plan are a friendly accommodation of MoCA with slightly less power usage on the HFC plant than the 1218 MHz plan. There is no real disadvantage with this plan unless the total power consumption is still greater than what the HFC plant budget permits.

8. 3 GHz Legacy Update Plan with a 1002/862/750 MHz Cross-over

Earlier we stated that very little HFC plant has been upgraded to 1218 MHz. Well, there is a lot of plant that is either at 1002 MHz or still at 862 MHz or 750 MHz. If that legacy frequency band determined the channel line-up and the HFC rebuild worked with that, what would it look like? These are just more variations of the 1100 MHz approach.

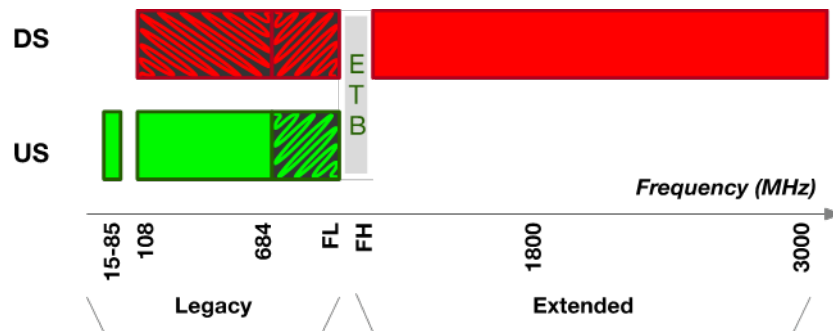

Figure 7: 3 GHz Legacy Plan

Figure 7 is a frequency plan built on the legacy frequencies of 750/862/1002.

Let's do the numbers.

Table 7: 3 GHz Legacy Plan with Classic FDX (Three Variations)

| Freq Range MHz | Comments | US Gbps | DS no FDX Gbps | DS with FDX Gbps |
|----------------------------|-----------------------------|----------|----------------|------------------|
| 15 to 85 | 70 MHz, 4 ATDMA + 0.5 OFDMA | 0.5 | | |
| 108 to 684 | 576 MHz, 6 OFDMA, 3 OFDM | 4.5 | | 5.5 |
| 684 to 750 | 66 MHz, 0.3 OFDM | | 0.6 | 0.6 |
| 684 to 862 | 178 MHz, 0.9 OFDM | | 1.7 | 1.7 |
| 684 to 1002 | 318 MHz, 1.7 OFDM | | 3.1 | 3.1 |
| 881 to 3000 | 2119 MHz, 11 OFDM | | 20.3 | 20.3 |
| 1013 to 3000 | 1987 MHz, 10.3 OFDM | | 19.1 | 19.1 |
| 1177 to 3000 | 1823 MHz, 9.5 OFDM | | 17.5 | 17.5 |
| Total Data Capacity | | 5 | 20 | 25 |

In Table 7 with a 684 MHz return path, the upstream data capacity is 5 Gbps. The downstream data capacity is 25 Gbps with FDX enabled and 20 Gbps with FDX not enabled.

In Table 8, an extended FDX upstream path, one that has not been defined yet in the standards, is presumed. In this example, the return path is 750/862/1002 MHz. The upstream data capacity is 5.5 Gbps to 7.5 Gbps. The downstream data capacity is 25 Gbps with extended FDX enabled and 17 Gbps to 20 Gbps without extended FDX enabled.

The advantage of these legacy plans is progressively less HFC power required as the transition band is lowered. Also, if the ESA fails, the entire legacy band would remain operational.

The disadvantage of these plans is that the ETB no longer overlaps a MoCA band, so if MoCA is present, it would further reduce the downstream bandwidth.

Table 8: 3 GHz Legacy Plan with Extended FDX

| Freq Range MHz | Comments | US Gbps | DS no FDX Gbps | DS with FDX Gbps |
|----------------------------|------------------------------|-------------------|-----------------|------------------|
| 15 to 85 | 70 MHz, 4 ATMDA + 0.5 OFDMA | 0.5 | | |
| 108 to 684 | 576 MHz, 6 OFDMA, 3 OFDM | 4.5 | | 5.5 |
| 684 to 750 | 66 MHz, 0.7 OFDMA, 0.3 OFDM | 0.5 | | 0.6 |
| 684 to 862 | 178 MHz, 1.9 OFDMA, 0.9 OFDM | 1.4 | | 1.7 |
| 684 to 1002 | 318 MHz, 3.3 OFDMA, 1.7 OFDM | 2.5 | | 3.1 |
| 881 to 3000 | 2119 MHz, 11 OFDM | | 20.3 | 20.3 |
| 1013 to 3000 | 1987 MHz, 10.3 OFDM | | 19.1 | 19.1 |
| 1177 to 3000 | 1823 MHz, 9.5 OFDM | | 17.5 | 17.5 |
| Total Data Capacity | | 5.5 to 7.5 | 17 to 20 | 25 |

9. 3 GHz Low Power Plan with a 684 MHz Cross-over

There is an FDX transition band (FTB) located above the current FDX upstream band that FDX cable modems observe. This transition band is usable by non-FDX CMs as well as video. This could be utilized as the extended spectrum transition band.

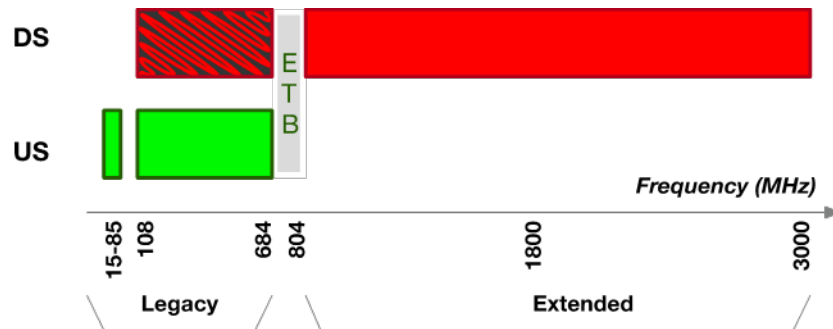

Figure 8: 3 GHz Low Power Plan

Figure 8 shows the frequency plan with a transition band just above 684 MHz. In this example, the ETB is identical to the FTB. This frequency range is also in the LTE band. This means that in a system that was all DOCSIS 3.1/4.0 with no video, then this band potentially could be left empty and there would be no interference from LTE and no plant leakage into the LTE frequencies.

Let's do the numbers.

Table 9: 3 GHz Low Power Plan with Classic FDX

| Freq Range MHz | Comments | US Gbps | DS no FDX Gbps | DS with FDX Gbps |
|----------------------------|-----------------------------|----------|----------------|------------------|
| 15 to 85 | 70 MHz, 4 ATMDA + 0.5 OFDMA | 0.5 | | |
| 108 to 684 | 576 MHz, 6 OFDMA, 3 OFDM | 4.5 | | 5.5 |
| 804 to 3000 | 2196 MHz, 11.4 OFDM | | 21 | 21 |
| Total Data Capacity | | 5 | 21 | 25 |

In Table 9 with a 684 MHz return path, the upstream data capacity is 5 Gbps. The downstream data capacity is 25 Gbps with FDX enabled and 21 Gbps with FDX not enabled.

There is no extended FDX scenario for this plan since the ETB is at 684 MHz.

The advantages of this plan are the absolute lowest power as the most downstream spectrum is shifted to the distributed amplification. The downstream extended cross-over band can be shared with the FDX guard band.

The disadvantage of this solution is that in if the extended spectrum amplifiers fail, there is only FDX downstream spectrum available, so non-FDX CMs and MPEG video STBs would lose their connection. This could be mitigated by only running FDX up to 492 MHz.

10. Comparison with DOCSIS 4.0 with FDX

DOCSIS 4.0 describes a DOCSIS 3.1 OFDM/OFDMA system with FDX operation. That spectrum plan is show in Figure 9.

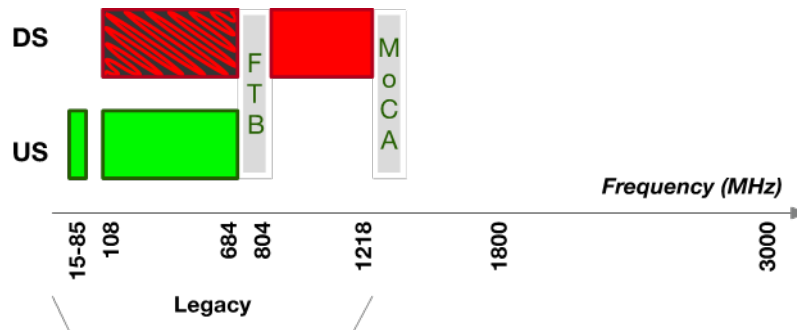

Figure 9: Frequency Plan with Extended FDX

Let's do the numbers.

Table 10: 1.218 GHz DOCSIS 4.0 with Classic FDX

| Freq Range MHz | Comments | US Gbps | DS no FDX Gbps | DS with FDX Gbps |
|----------------------------|------------------------------|----------|----------------|------------------|
| 15 to 85 | 70 MHz, 4 ATMDA + 0.5 OFDMA | 0.5 | | |
| 108 to 684 | 576 MHz, 6 OFDMA, 3 OFDM | 4.5 | | 5.5 |
| 684 to 804 | 120 MHz, 0.6 OFDM (1.1 Gbps) | | 0 or 1.1 | 0 or 1.1 |
| 804 to 1218 | 414 MHz, 2.2 OFDM | | 4 | 4 |
| Total Data Capacity | | 5 | 4 or 5 | 9.5 or 10 |

In Table 10, with a 684 MHz return path, the upstream data capacity is 5 Gbps. The aggregate downstream data capacity is about 10 Gbps with FDX enabled and 5 Gbps with FDX not enabled. A single FDX CM will receive slightly less due the FTB, making the throughput 9.5 Gbps down with FDX and 4 Gbps without FDX.

11. Comparison with DOCSIS 4.0 with 1.8 GHz Extended Spectrum

The DOCSIS 4.0 specifications for 1.8 GHz extended spectrum are not written at this time, so this paper makes some assumptions.

- Return path choices are 204 MHz, 300 MHz, 492 MHz and 684 MHz. For this example, a return path of 492 MHz has been chosen. For 1.8 GHz extended spectrum, this allows for a 3:1 ratio of DS to US bandwidth. For a 3.0 GHz extended spectrum, this allows for a 6.4:1 ratio, both of which are respectable.
- A passive transition band was chosen without reduced guard band (RGB) and thus no active echo cancellers. This allows an inexpensive amplifier to be built.
- A transition band of 96 MHz (492 to 588 MHz) was chosen. That is a ratio of 1.95:1 which is more conservative than the 1.175:1 ratio used in the other scenarios but is what is close to what is in current discussions. 96 MHz allows sixteen 6 MHz video channels or twelve 8 MHz video channels.
- In case MoCA is a problem, the simplest MoCA solution (a) of 150 MHz was chosen.

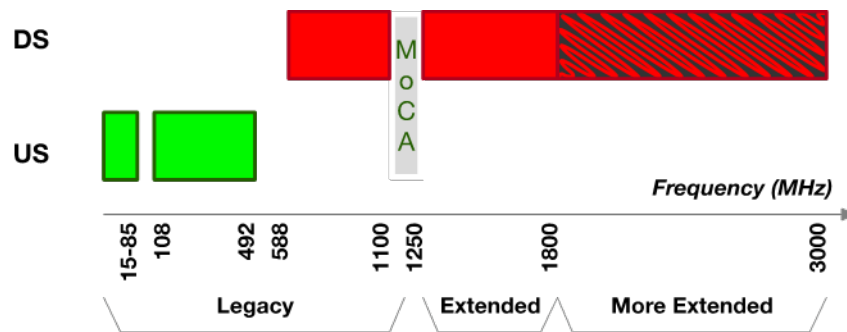

Figure 10: 1.8 GHz Static FDX Frequency Baseline

Let's do the numbers.

Table 11: 1.8 GHz DOCSIS 4.0 with No FDX

| Freq Range (MHz) | Comments | US (Gbps) | 1.8 GHz (Gbps) | 3 GHz (Gbps) |
|------------------|-------------------------------|------------|-------------------|-------------------|
| 15 to 85 | 70 MHz, 4 ATMDA + 0.5 OFDMA | 0.5 | | |
| 108 to 492 | 384 MHz, 4 OFDMA | 3.1 | | |
| 588 to 1100 | 512 MHz, 2.7 OFDM | | 4.9 | 4.9 |
| 1100 to 1250 | 150 MHz, 1.4 OFDM, (1.4 Gbps) | | 0 or 1.4 | 0 or 1.4 |
| 1250 to 1800 | 550 MHz, 5.3 OFDM | | 5.3 | 5.3 |
| 1800 to 3000 | 1200 MHz, 11.5 OFDM | | | 11.5 |
| | Total Data Capacity | 3.6 | 10 or 11.5 | 21.5 or 23 |

In Table 11, with a 492 MHz return path, the upstream data capacity is 3.6 Gbps. The downstream data capacity for a 1.8 GHz system is about 11.4 Gbps without MoCA and 10 Gbps if allowing for MoCA and the DS:US ratio would be 3:1. If this system were later extended to 3 GHz, the downstream capacity would be 23 Gbps without MoCA and 21.5 Gbps with MoCA and the DS:US ratio would be 6.3:1.

The advantage of this system is that it is simple to understand and build. It is just an ultra-high split. There are no echo cancellers. The amplifier can be inexpensive, and the node will be less expensive. Single channel MoCA can also be accommodated by giving up some downstream bandwidth. There is enough bandwidth to support legacy video and legacy DOCSIS. CMs that have a 684/804 FDX transition band could coexist in this spectrum plan.

The disadvantage of this system is less upstream bandwidth than an FDX system. However, at ratios of 3:1 and 6.3:1, one could argue that is enough bandwidth. Still, this system will never meet the 10 Gbps upstream goals set by the 10G initiative.

12. Summary

The throughput of the various spectrum plans are shown in Table 13.

Table 12: Spectrum Plan Data Capacity Summary

| Plan | ETB | With Classic FDX (Gbps) | | | With Extended FDX (Gbps) | | |
|-----------|--------------|-------------------------|---------|-------|--------------------------|---------|-------|
| | | US | 1.8 GHz | 3 GHz | US | 1.8 GHz | 3 GHz |
| Premium | 1218 to 1431 | 5 | 20 | 25 | 9.3 | 15 | 25 |
| MoCA | 1100 to 1300 | 5 | 20 | 25 | 8.4 | 16 | 25 |
| Legacy | 1002 to 1177 | 5 | 20 | 25 | 7.5 | 20 | 25 |
| Min Power | 684 to 804 | 5 | 21 | 25 | - | - | - |
| D4.0 | 684 to 804 | 5 | 5 | 10 | - | - | - |
| 1.8 ESD | No FDX | 3.6 | 11.5 | 23 | - | - | - |

3 GHz Passive Taps

13. 3 GHz Tap specifications

The coaxial network consists of three main components: coaxial cables, taps and amplifiers. The propagation loss of coaxial cables is well studied and understood for the frequency range of interest (5 MHz to 3 GHz). The study of 3 GHz amplifier technology is discussed later in this paper. This section presents the study and prototype of 3 GHz taps.

Cisco worked with a tap ODM to prototype a series of 3 GHz taps. Three tap values were selected for the prototype development: tap14, tap20 and tap26. The targeted 3 GHz tap specifications are given in Table 13.

Table 13: 3 GHz Tap Specifications

| Targeted 3GHz Tap Specifications | | | | | | |
|---|-----------------|------------------|------------------|------------------|------------------|------|
| Model 4-Way | | 4-14 | 4-20 | 4-26 | | |
| Parameter | | Value | 14dB | 20dB | 26dB | |
| Tap Loss (dB) | Tap Tol. | Frequency | Nominal | Nominal | Nominal | |
| | | | Tap Value | Tap Value | Tap Value | |
| | ±1.5 | | 5-10 | 12.5 | 20.5 | 26.5 |
| | | | 11-50 | 12.5 | 20.5 | 26.5 |
| | | | 51-450 | 12.5 | 20.5 | 26.5 |
| | | | 451-750 | 12.5 | 20.5 | 26.5 |
| | | | 751-870 | 12.5 | 20.5 | 26.5 |
| | | | 871-1003 | 12.5 | 20.5 | 26.5 |
| | ±2.0 | | 1004-1250 | 12.5 | 21 | 27 |
| | | | 1251-1950 | 13 | 21 | 27.5 |
| | | 1951-2250 | 13 | 21 | 27.5 | |
| | | 2251-2500 | 14.5 | 22 | 28 | |
| | | 2501-2750 | 15.5 | 23 | 28 | |
| | 2751-3000 | 16 | 23.5 | 28 | | |
| | | Frequency | Typical | Typical | Typical | |
| | | 5 | 2.3 | 1.3 | 0.6 | |
| | | 50 | 3.8 | 1.3 | 0.6 | |
| | | 450 | 3.8 | 1.5 | 0.7 | |
| | | 750 | 3.8 | 1.6 | 0.8 | |
| TYPICAL | | 870 | 3.6 | 1.7 | 0.9 | |
| Insertion Loss (dB) | | 1003 | 3.6 | 1.7 | 1 | |
| | | 1250 | 3.8 | 1.8 | 1.1 | |
| | | 1950 | 4.2 | 2.2 | 1.2 | |
| | | 2250 | 4.7 | 2.3 | 1.3 | |
| | | 2500 | 4.8 | 2.6 | 1.5 | |
| | | 2750 | 5 | 3 | 1.8 | |
| | | 3000 | 5.5 | 3.5 | 2.3 | |

The prototype includes the following aspects:

1. The coupler that operates from 5 MHz to 3 GHz with the designed coupling coefficients
2. The pin seizure that operates from 5 MHz to 3 GHz. The insertion loss of the pin seizure is a part of the overall tap insertion loss which is specified in Table 13.
3. The AC choke (AC bypass). Its loss is also a part of the overall tap insertion loss which is specified in Table 13.
4. The DC coupler. Its loss is also a part of the overall tap insertion loss which is specified in Table 13.
5. The bypass beam.

All the components are included in the tap housing which is slightly larger than the current tap housing (see Figure 11)



Figure 11: 3 GHz tap prototype

One key aspect not covered in this paper is tap equalization, also referred to as signal conditioning. Signal conditioning plug-ins are inserted into taps to equalize tilt in the drop signal without impacting main feeder path. Current Plug-ins work for frequency range up to 1.2 GHz. When extending these plug-ins to 3 GHz DOCSIS, we have to consider how the signal need to be conditioned for optimal 3 GHz DOCSIS reception. Here we have to take into account multitude of factors, such as the original tilt of transmit signals, the network induced down tilt over the frequency range of interest, receiver capability in handling tilt in input RF signal. The topic of optimal transmit power allocation, which in some cases lead to an up-tilted transmit signal, is discussed later in this paper.

14. 3 GHz Tap Prototype Test Results

Figure 12 to Figure 17 show the test data of the insertion losses and tap losses for tap14, tap20 and tap26. The curves labeled as JL are the original design specs, and the curves labeled as CV are the revised design specs.

In the world of taps, insertion loss is the loss created along the main cable from the input to the output of the tap. It is additive with each tap and additive to the loss of the main cable. The tap loss is the loss from the input of the tap to the tap port output that feeds the drop cable. The tap loss is by design to help create a consistent loss plan for the HFC plant where each CM is presented with a similar power level. The insertion loss is a by-product and ideally is as low as possible.

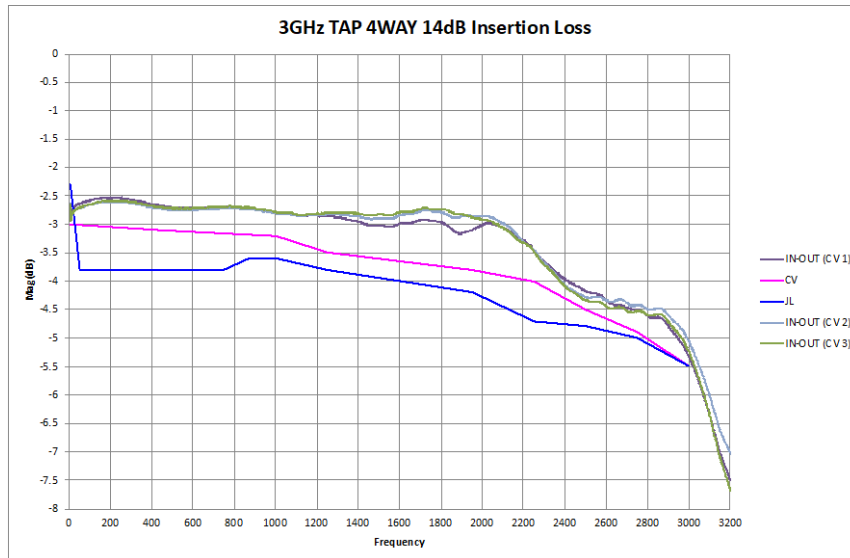

Figure 12: Test data for Tap14 insertion loss

In the 14 dB tap, there is up to 5.5 dB of attenuation at 3 GHz. However, at 1.2 GHz, there is 3.5 dB attenuation, so the extra attenuation going up to 3 GHz is only 2 dB.

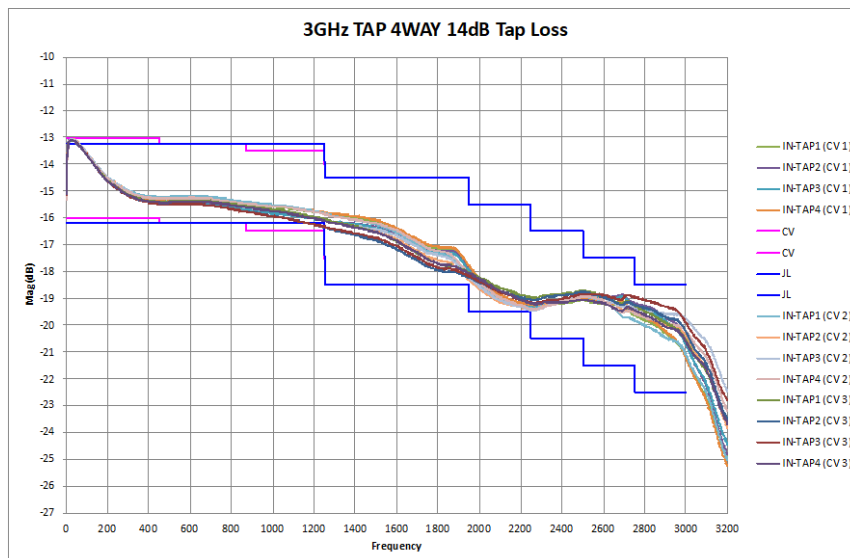

Figure 13: Test data for Tap14 tap loss

The deviation of tap14 loss from the nominal 14 dB value increases with the frequency. For frequencies up to 1.2 GHz, the tap loss is within 2 dB of the nominal value of 14 dB. As the frequency reaches 3 GHz, the deviation reaches as high as 7 dB.

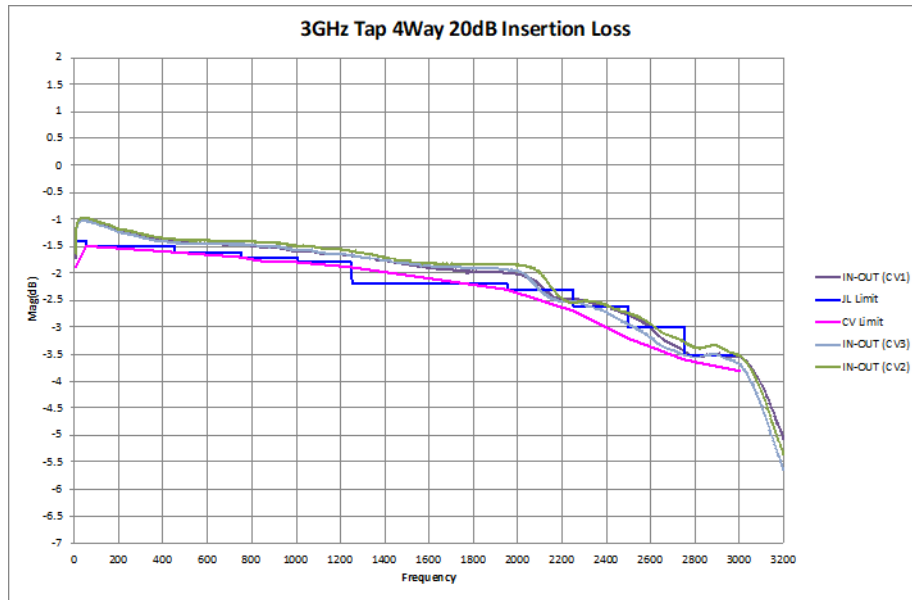

Figure 14: Test data for Tap20 insertion loss

In the 20 dB tap, there is up to 3.5 dB of attenuation at 3GHz. However, at 1.2 GHz, there is 1.8 dB attenuation, so the extra attenuation going up to 3 GHz is only 1.2 dB.

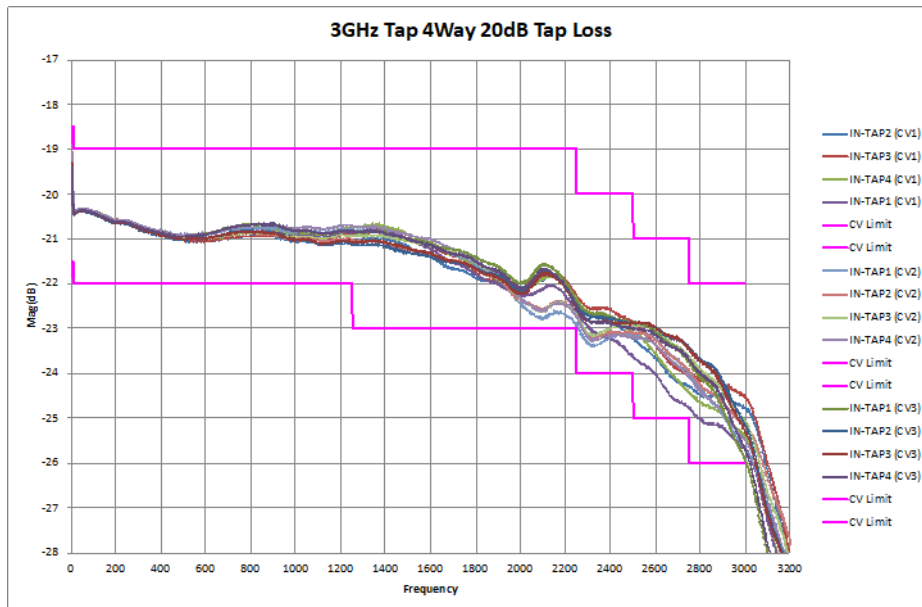

Figure 15: Test data for Tap20 tap loss

As in tap14, the deviation of tap20 loss from the nominal 20 dB value increases with the frequency. For frequencies up to 1.2 GHz, the tap loss is within 1.2 dB of the nominal value of 20 dB. As the frequency reaches 3 GHz, the deviation increases to 6 dB.

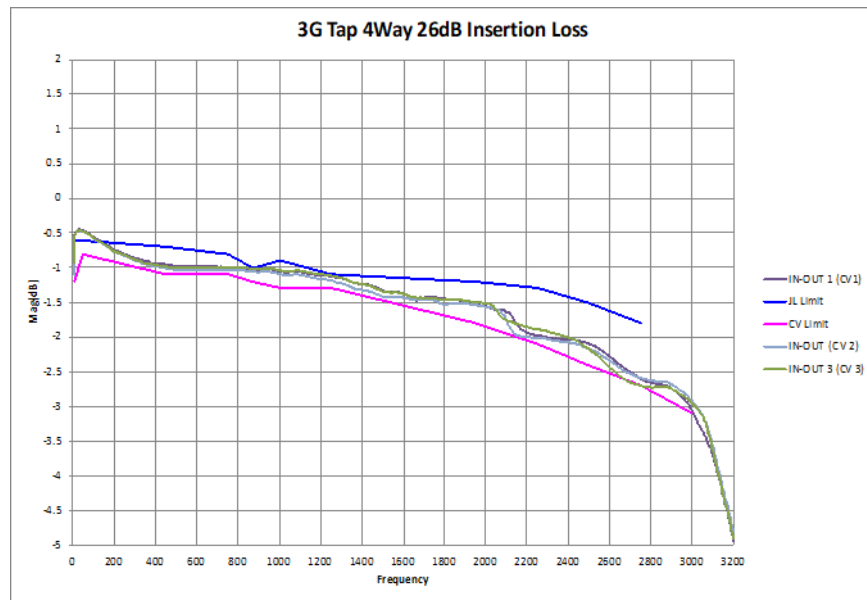

Figure 16: Test data for Tap26 insertion loss

In the 26 dB tap, there is up to 3 dB of attenuation at 3GHz. However, at 1.2 GHz, there is 1.2 dB attenuation, so the extra attenuation going up to 3 GHz is only 1.8 dB.

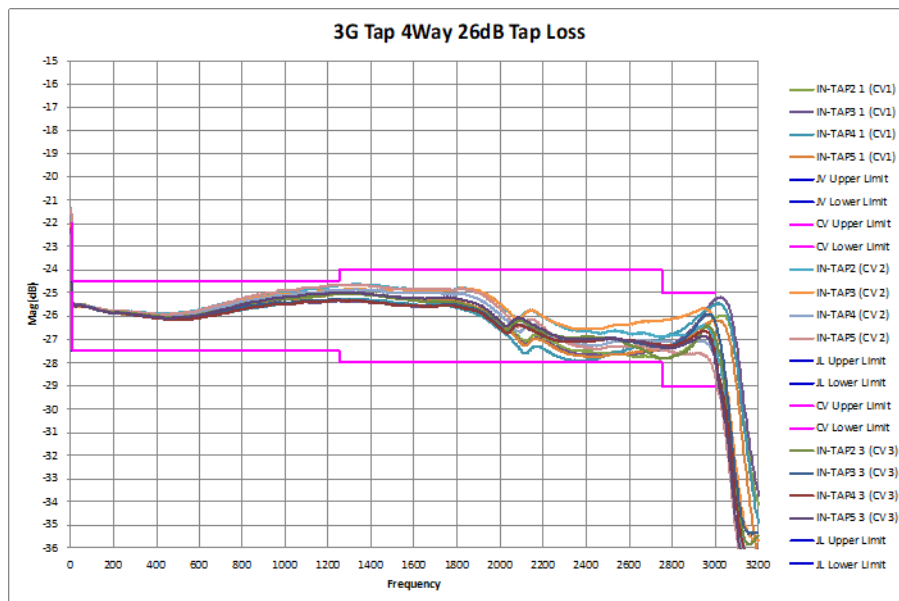

Figure 17: Test data for Tap26 tap loss

As in the previous two cases, the deviation of tap26 loss from the nominal 26 dB value increases with the frequency albeit at the lower average slope. For frequencies up to 1.2 GHz, the tap loss is within 1.2 dB of nominal value of 26 dB. As the frequency reaches 3 GHz, the deviation reaches 2 dB.

In summary, for the 3 tap cases discussed above, the extra insertion loss going from 1.2 GHz to 3 GHz is in the range of 2 dB to 1.2 dB. These losses integrate as the signal travel further down the trunk coax network, passing taps along the way, leading to additional down-tilt in the signal as it travels further away

from the point of transmission. Similarly, the deviation of tap losses from the nominal tap values generally increases with frequency, leading to more losses than intended by the tap. Additional losses here can be as high as 7 dB, but fortunately the tap losses from a particular tap only impact devices connected to that tap. In other words, these losses do not integrate along the trunk coax network. Both these loss factors and the range of losses discussed here are manageable within the 3 GHz DOCSIS framework developed here. Applying an up-tilt to transmit signal is an effective way to pre-equalize the signal to counter expected down-tilt of coax channel. This topic is covered extensively in the next section. Furthermore, the tap equalizers mentioned before is another tool available to MSOs to manage the tilt in signal spectrum in tap output going into drop network in a more localized manner.

Power Plans

15. Distributed Power Amplification

When the operating frequency range is extended from 5 MHz to 1.2 GHz to 5 MHz to 3 GHz, the network needs to provide extra AC power to support the extra spectrum and related services. Just to support the existing operating frequency range (5 MHz to 1.2 GHz), the AC power grid is configured to run at its full capacity. To provide extra AC power for the spectrum between 1.2 GHz to 3 GHz will require a potentially expensive upgrade to the network power grid. The ideal case is to maintain the same AC power to avoid an expensive power grid upgrade, while extending the operating frequency range to 5 MHz to 3 GHz.

In general, when we look at the overall network power consumption, there are two factors that need be considered: the number of active devices (amplifiers) and the power consumption of each active device. The total power consumption will be the sum of the power consumptions of all devices. In one extreme case, we could place an amplifier in each tap, and the TCP of each amplifier is very low since it only needs to overcome the path loss of a very short section of coaxial network.

In this case, the total power consumption of the network will be low, but the number of the active devices is high. In the other extreme case, we place amplifiers with the same interval as the legacy network (4-5 tap interval). In this case, the number of active devices remains the same, but the power consumption is high: the amplifier needs to deliver the same RF power for the legacy 5 MHz to 1.2 GHz spectrum, and at the same time needs to deliver RF power for the 1.2 GHz to 3 GHz extended spectrum, which experiences much higher path loss. The optimal solution is somewhere in between.

The optimal power allocation scheme is nicknamed a Robin Hood power scheme: the whole DS spectrum is partitioned into the low spectrum from 5 MHz to 684 MHz, which is denoted as LS, and the extended spectrum is 804 MHz to 3 GHz, denoted as ES. 684 MHz to 804 MHz will be the cross over band (Figure 18)

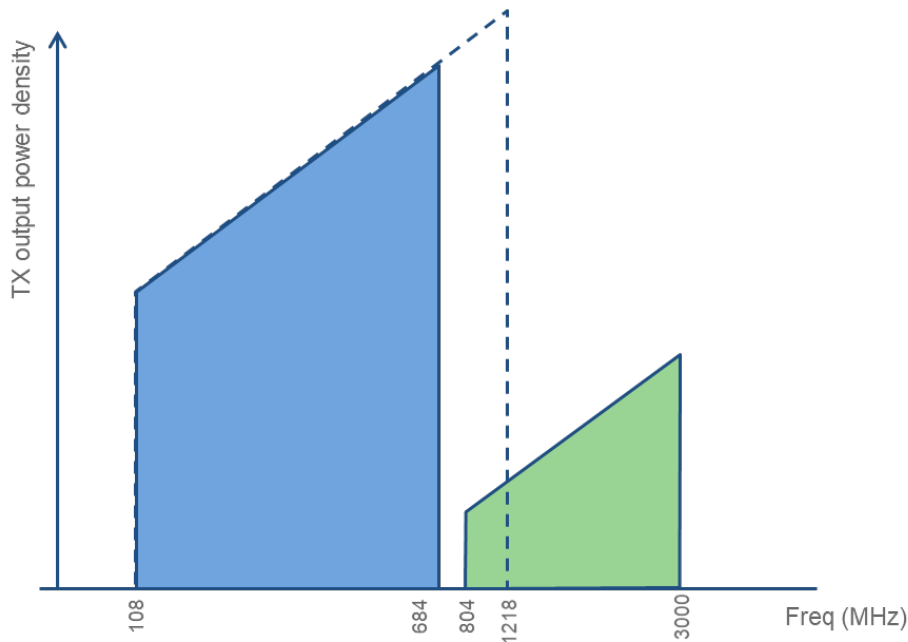

Figure 18: The spectrum partition

Compared to the legacy spectrum (108 MHz to 1.2 GHz), the new low spectrum (108 MHz to 684 MHz) reduced the power consumption of the legacy system. The saved power will be used to support the power required for the extended spectrum while keeping the same or even lower the total power consumption of the network. LS and ES can run as two independent networks with different amp intervals.

One approach to accomplish this is with the use of a hybrid active tap (HAT) as shown in Figure 19.

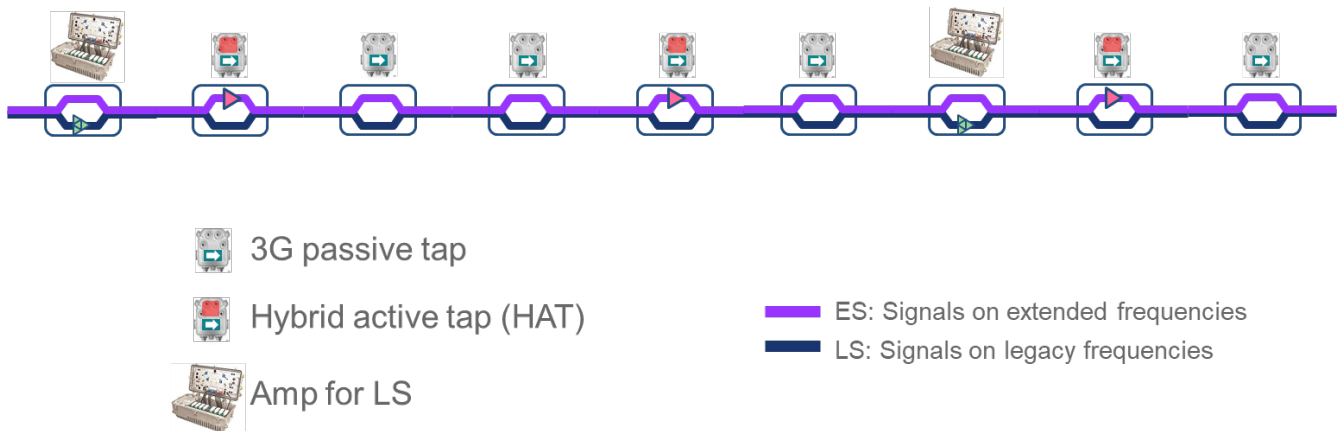

Figure 19: Hybrid Active Tap

The HAT is constructed as follows: The incoming signal is split into LS and ES at the diplexers, and ES will go through the top branch where it is amplified. LS will go the bottom branch without amplification. The coupler coefficients, such as the EQ values, could be different for LS and ES, depending on the link budget and design. This is shown in Figure 20. To prevent feedback from occurring on the ESA within the tap, a transition band is required that will be implemented in the diplexers on either side of the ESA.

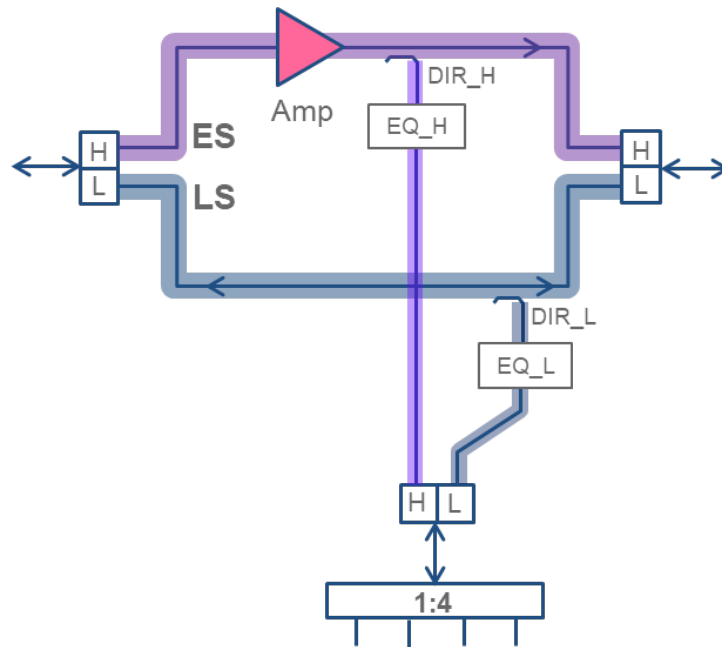

Figure 20: HAT block diagram

One needs to trade-off between the number of active devices and total power consumption of the network. Figure 21 presents the simulation results of total AC power consumption vs number of amplifiers for N+2 network:

- 200 HHP
- 24 HHP per tap
- Link budget: >-8 dBmV/6 MHz at CM @3 GHz
- 3% power efficiency (AC->RF)

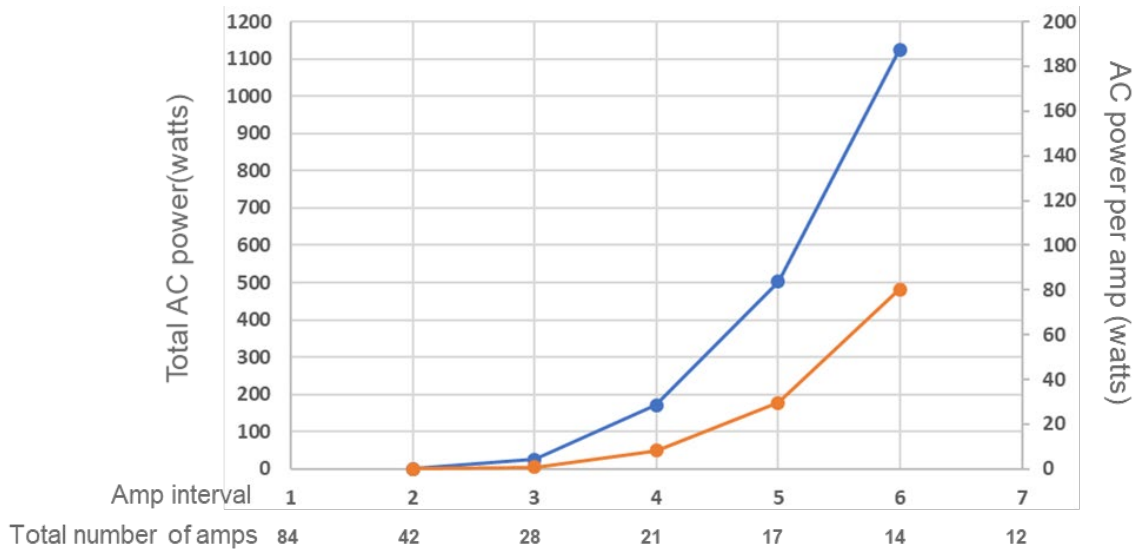

Figure 21: Simulation results of total AC power consumption vs number of amplifiers for N+2 network

16. Optimization of Transmit Power for Capacity

One of the key technology challenges in extending the DOCSIS spectrum beyond the current 1.2 GHz spectrum is the limited total composite power of transmit power amplifiers as explained previously. Silicon technology indicates that the TCP of 3 GHz PAs would need to be around the same mark as current 1.2 GHz PAs if we are to achieve the level of signal fidelity required to target higher order modulations.

For 1.2 GHz DOCSIS FDX, downstream transmit reference power spectral density (PSD) is defined in the standard [1] as having an up tilt of 21 dB, 37 dBmV/6 MHz at 108 MHz to 58 dBmV/6 MHz at 1218 MHz. The up tilt is there to counter the cable losses that monotonically increase with frequency.

Given TCP constraint mentioned above, we do not have excess headroom in PAs to allocate any power for the extended spectrum in the 1.2 GHz to 3 GHz range, let alone maintain the current level of up tilt. Hence, we need to rethink the transmit power allocation for 3 GHz ESD.

Firstly, we outline a theoretical framework to calculate the optimal power allocation given PA-related constraints and the cable plant characteristics. Following that, we show that additional constraints, such as backwards compatibility, can be incorporated in this framework to devise a power allocation strategy that is both non-disruptive to existing devices in the network and optimal for ESD devices.

16.1. Theoretical Framework

The capacity of HFC network for 3 GHz ESD is impacted by the propagation channel characteristics and capacity limiting factors in the transmitter and receiver. Our aim here is to optimize the transmit power distribution taking into account capacity limiting factors related to link budget. In that regard, the dominant capacity limiting factors in the DOCSIS transmitter is PA distortion. At the receiver end, additive white Gaussian noise as well as receiver distortion and noise due to analog-to-digital conversion limit capacity.

Other performance limiting factors, such as transmit and receive phase noise, are not directly linked to transmit power and considered outside the scope of this analysis. In this subsection, we outline the theoretical framework for optimizing capacity of the network subjected to the above factors and the constraint on TCP.

HFC transmission schemes such as DOCSIS 3.1 [1] use OFDM, where the channel is partitioned into K narrowband subcarriers $k = 1, \dots, K$ with a subcarrier spacing Δf . Those orthogonal subcarriers are coupled only by nonlinear distortion or a sum power constraint. The transmit power per carrier $x(k)$ as well as the information rate per carrier $b(k)$ can be adjusted per carrier. The overall data rate R where k 'th subcarrier signal-to-noise ratio $SNR(k)$ is given by,

$$R = \eta \Delta f \sum_{k=1}^K \min \left\{ \log_2 \left(1 + \frac{SNR(k)}{\Gamma} \right), b_{max} \right\} \quad (1)$$

Where Γ is a scalar, whose value is greater than unity, representing the SNR gap to Shannon capacity for the modulation and coding scheme used. This equation also captures the impact of the limit on the number of bits per subcarrier, b_{max} . The efficiency factor, $\eta < 1$, captures overhead due to factors such as cyclic extension in OFDM and redundancy in forward error correction (FEC). Using $\eta = 1$, $\Gamma = 1$ and $b_{max} \rightarrow \infty$ gives the capacity without coding and modulation limitations.

To formulate the constrained capacity optimization problem mentioned above, we expand the SNR in equation (1) and also lay out the constraints in mathematical form as follows, leading to a smooth (differentiable) form for capacity,

$$C = \max_{x(k)} \sum_{k=1}^K \log_2 \left(1 + \frac{H(k)x(k)}{\Gamma\sigma^2(k)} \right) \quad (2)$$

where:

$H(k)$ is the channel coefficient, (attenuation, phase), for subcarrier k

$\sigma^2(k)$ is the additive white Gaussian noise variance on subcarrier k

subjected to:

$$\text{TCP constraint: } \sum_{k=1}^K x(k) \triangleq \text{TCP}$$

$$\text{Spectral mask constraint: } 0 \leq x(k) \leq p_{\text{mask}}(k)$$

Spectral mask constraint captures the limitation of the modulation alphabet as follows,

$$p_{\text{mask}}(k) = \Gamma \frac{(2^{b_{\text{max}}}-1)\sigma^2(k)}{|H(k)|^2} \quad (3)$$

Overall noise variance, $\sigma^2(k)$ need to include both receiver contributions as well transmitter contributions. Transmitter contributions are dominated by the PA nonlinear floor, which is a function of TCP, p_{sum} . Furthermore, both receiver noise and transmit nonlinearity contribution may have a frequency dependency. Hence we can write noise power in general from as,

$$\sigma^2(k) = \sigma_n^2(k) + \sigma_t^2(k, x(1), \dots, x(K)) \quad (4)$$

where $\sigma_n^2(k)$ represents receiver noise and $\sigma_t^2(k, x(1), \dots, x(K))$ represent transmit distortion referred to the receiver end. PA nonlinear noise floor at the transmitter output is a function of TCP and it gets scaled by channel response before reaching the receiver.

The following figures shows simulation results for how the nonlinear distortion floor varies across frequency for given TCP and power distribution – flat and non-flat PSD, and the average MER vs TCP.

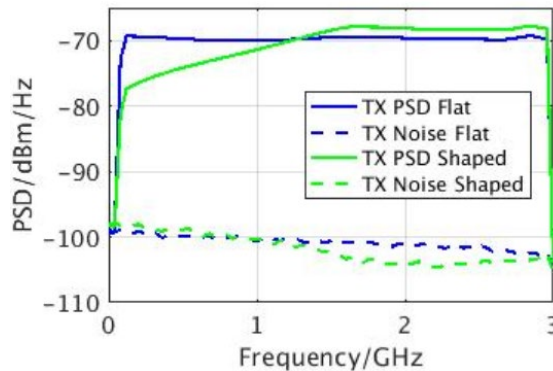

Figure 22: PA nonlinear distortion characterisation (source: Qorvo 3 GHz PA simulation data)

Simulation results shows that the shape of nonlinear distortion PSD is largely unaffected by the shape of transmit PSD for a given TCP. Hence, we can write $\sigma_t^2(k)$ in following form to accurately model channel scaling and PA behavior shown above,

$$\sigma_t^2(k) = \sigma_d^2(k, TCP)|H(k)|^2 \quad (5)$$

where $\sigma_d^2(k, TCP)$ is the nonlinear distortion in subcarrier k at the output of the transmitter. Note that σ_t^2 here is a function of TCP , but not individual subcarrier power levels as given in (4).

For the above optimization problem, we consider TCP to be fixed. Hence the overall noise floor seen at the receiver end, $\sigma^2(k)$, is independent of power allocation. More generalized case of flexible TCP , where the received noise floor varies with TCP is outside the scope of this paper and will be published in a conference paper soon.

The solution for the optimization problem described in equations (2) to (5) can be shown to be a form of water filling solution [5].

$$\frac{|H(k)|^2}{\Gamma\sigma^2(k)+|H(k)|^2x(k)} - \frac{1}{\mu} = 0 \quad \forall k, \quad 0 \leq x(k) \leq p_{mask}(k) \quad (6)$$

where the relationship between μ and TCP is given by,

$$\frac{1}{\mu} = \frac{1}{|I_{fill}|} \left(TCP + \sum_{k \in I_{fill}} \frac{\Gamma\sigma^2(k)}{|H(k)|^2} - \sum_{k \in I_{mask}} p_{mask}(k) \right) \quad (7)$$

where I_{fill} is the set of subcarriers where water filling condition in (6) is met, and I_{mask} is set of subcarriers where the spectral mask is hit before the water filling level is reached. $|I_{fill}|$ denotes the cardinality of set I_{fill} .

Equation (7) leads to a practical implementation of the algorithm: First calculate the noise variance per subcarrier referred to the transmitter, $\frac{\Gamma\sigma^2(k)}{|H(k)|^2}$. Then the transmit power is filled into subcarriers to maintain constant $\frac{\Gamma\sigma^2(k)}{|H(k)|^2} + x(k)$ level while keeping an eye on per-subcarrier transmit power mask, $p_{mask}(k)$. Subcarriers that reaches $p_{mask}(k)$ power level are stopped from receiving any more power. This filling process continues until total power allocation reaches the TCP.

16.2. Backwards Compatible and Optimal Power allocation

The optimal power allocation algorithm given above can be applied directly if there were no requirement for backwards compatibility. However, in DOCSIS, cable operators generally like to do upgrades while maintaining backwards compatibility to allow gradual phasing out of existing devices (CMs in particular) in the network.

We can apply the power optimization algorithm with the additional constraint of backwards compatibility. Assume we maintain the upto in PSD up to 750 MHz to maintain backwards compatibility with legacy devices, which includes FDX DOCSIS devices. We can apply an optimal algorithm to optimize capacity over the 750 MHz to 3 GHz spectrum using the remaining power.

With the added requirement of backwards compatibility with DOCSIS-FDX and legacy DOCSIS, we end up with two options for the downstream power allocation for 3 GHz ESD as shown in Figure 23.

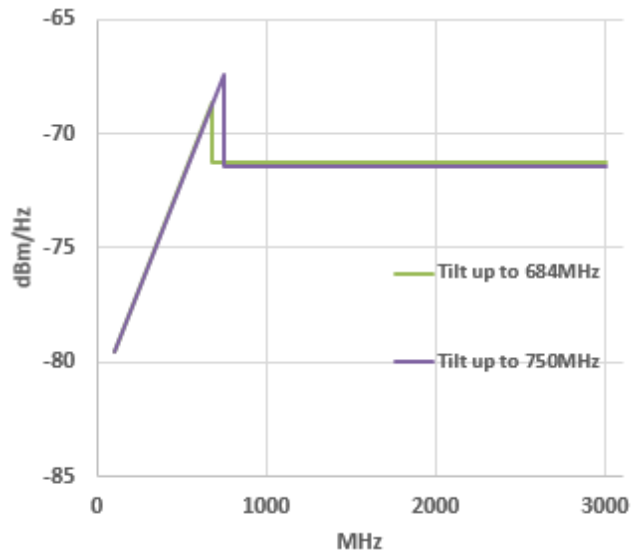

Figure 23: Optimal Power Allocation for backwards compatible 3 GHz ESD

The two options are as follows:

- Option 1: Maintain DOCSIS FDX reference PSD for the FDX band (up to 684 MHz). Then allocate the remaining power optimally.
- Option 2: Maintain DOCSIS FDX reference PSD not just for FDX band but to cover the frequency range for any legacy devices in the network (e.g., 750 MHz used here). Then allocate the remaining power optimally.

16.3. Results and Conclusions

An end-to-end simulation model is used to compare capacity for the N+0 Comcast Model I [12] network, as shown in Figure 24, with and without transmit power optimization.

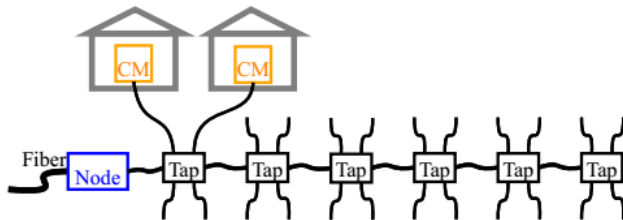

- Trunk cables are 175 feet of type QR540
- Drop cables are 100 feet of type RG6
- 6 taps of 29 dB, 29 dB, 26 dB, 20 dB, 14 dB, 8 dB

Figure 24: Comcast Model I

PA nonlinearity is modelled based on Qorvo data and network taps are assumed to be upgraded to 3 GHz. Cable modem point of entry (PoE) installation, where the CM is professionally installed at the point where the drop cable enters the customer premises, and deep home run (additional 100 feet cable from PoE) self-install scenario is shown in **Figure 25**. The spectrum below 1.2 GHz is assumed to be as defined in DOCSIS 4.0 FDX. The spectrum beyond 1.2 GHz is considered all downstream. **Figure 25** shows downstream and aggregate (downstream + upstream) capacities of the network.

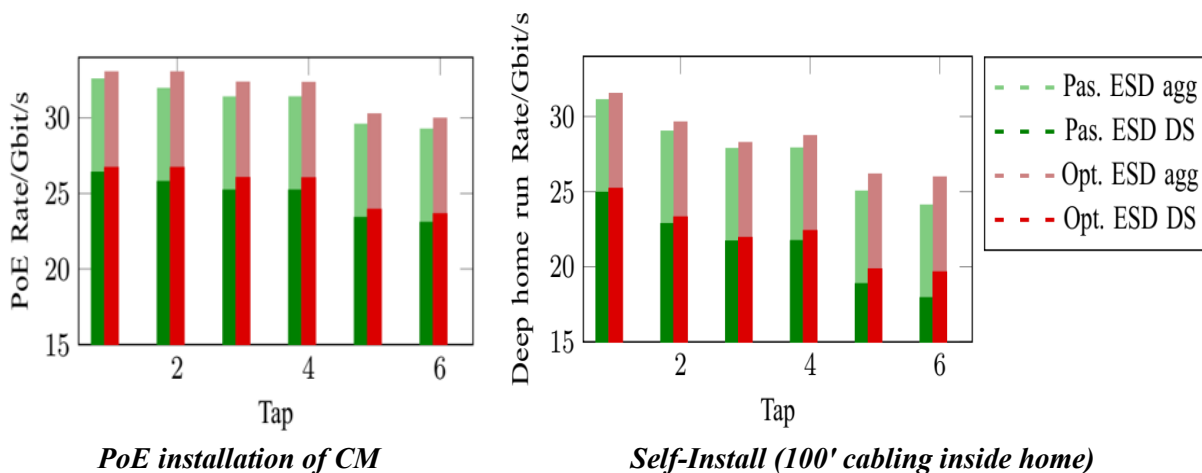

Figure 25: Capacity with and w/o transmit power optimization

In summary, optimal power allocation follows the water filling principle with added complexity having to deal with sum of all noise and distortion sources. The solution can be found iteratively. Generally, the optimal solution has an up-tilted spectrum at lower frequencies and flat power allocation in higher end frequencies. Power optimization improves capacity by 3-5% for PoE and up to 8% for deep home run (home wiring of 100' RG6).

DOCSIS PHY Optimizations

17. Introduction

OFDM with a conventional cyclic prefix (CP) [6] is an elegant multicarrier modulation scheme, which offers all the advantages associated with multicarrier systems, such as SNR vs frequency dependent bit loading, frequency domain one tap equalization, for a small overhead of cyclic prefix. There are other multicarrier options found in the literature that reduce or eliminate the cyclic prefix [7], but these come with added complexity and hardware resources, such as memory. In a nutshell, we can summarize reasons why we should continue with OFDM for 3 GHz ESD as follows,

- a) With time and frequency interleaving in place, OFDM is very robust to both burst and ingress interference
- b) Simplified transceiver architecture: e.g., efficient modulation/demodulation with FFTs, one tap equalization

- c) Robust against multipath - easily dealt with guard interval (cyclic prefix)
- d) Sensitivity to phase noise and time variations more than single carrier modulation, but these can be mitigated by well-known algorithms – CPE correction, adaptive channel estimation.
- e) With narrow subcarriers (e.g., 50 kHz), bit loading can be used to optimize throughput with fine frequency resolution
- f) Classic cyclic prefix OFDM as in DOCSIS 3.1/FDX is recommended. We can reduce CP overhead for ESD. More complex multicarrier schemes lose some of the above advantages – b, c

In this section, we show that DOCSIS 3.1 OFDM parameters are well suited for 3 GHz ESD with potentially reduced cyclic prefix overhead for the extended part of the spectrum. We also explore potential extensions to DOCSIS 3.1 OFDM to support 3 GHz.

18. A Systematic Approach to Selecting OFDM Parameters

The two key parameters for OFDM are the useful symbol duration, T_u , and the cyclic prefix, T_{cp} . Once these are determined, the number of subcarriers in an OFDM channel are defined based on individual OFDM channel bandwidths required to give per-channel throughput. Channel bandwidth is more of a high-level PHY decision to be made based on how you’d like to organize the DOCSIS spectrum into channels. This could also have hardware implications that need to be taken into account.

18.1. Target MER

When looking for suitable OFDM parameters, target MER is the key metric of consideration. The upper bound for MER for 3 GHz ESD can be worked out from a link budget analysis of the representative ESD systems. Figure 26 shows MER results of a full system (transmitter, network, and receiver) simulation. The MER values achieved for CMs connected to different taps in the Comcast Model I are shown here.

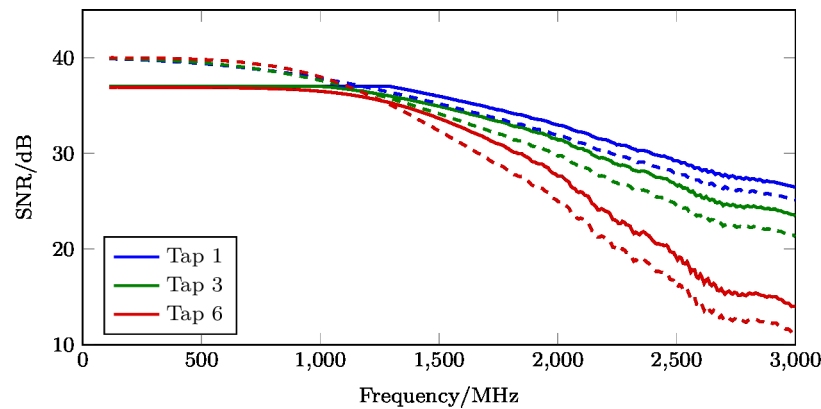

Figure 26: Optimized SNR (solid) and SNR achieved with flat transmit PSD (dashed)

At lower frequencies, we are targeting MER of 37.5 dB and at higher frequencies 30 dB looks like a realistic target (at least for some CMs). With many such system analysis, we can determine a target MER mask for 3 GHz ESD. In the following sections, we assume we are targeting a 35 dB MER in the ESD spectrum.

18.2. Cable Propagation Channel

DOCSIS 3.1 [1] defines individual micro-reflection masks for the downstream channel shown in Table 14.

Table 14: DOCSIS 3.1 DS Micro-Reflection Bound (mask)

| Echo Delay | dBc Level |
|------------------------|-----------|
| $\leq 0.5 \mu\text{s}$ | -20 |
| $\leq 1.0 \mu\text{s}$ | -25 |
| $\leq 1.5 \mu\text{s}$ | -30 |
| $> 2.0 \mu\text{s}$ | -35 |
| $> 3.0 \mu\text{s}$ | -40 |
| $> 4.0 \mu\text{s}$ | -45 |
| $> 5.0 \mu\text{s}$ | -50 |

This channel spec is based on return losses and propagation losses in passive elements, including the cable itself, in the network. Surveying return losses for various passives in network, 10-12 dB seems reasonable worst case we can expect. There are at least two reflections for each echo in the forward channel. Hence, -20 dB for very short echoes, as given in Table 14, is a reasonable mask. Even higher losses for longer echoes seen in Table 14 can be attributed to cable losses and other insertion losses in the cable channel.

There are two broad types of cables in network - drop cables and hardline distribution cables, that need to be considered when calculating the cable attenuation in the network. We used an extensive collection of cable S-parameter data from CableLabs [11] to create a summary of cable loss vs frequency for a 0.5 μs individual echo given in Table 15.

Table 15: Coax Cable Losses for 0.5 μs echo

| | 100 MHz | 1 GHz | 2 GHz | 3 GHz |
|---------------------|---------|--------|---------|---------|
| Drop | 6.5 dB | 20 dB | 30 dB | 36.7 dB |
| Distribution | 3 dB | 7.6 dB | 10.4 dB | 13.3 dB |

Note that for each increment of 0.5 μs delay, the echo level in Table 14 decreased by 5 dBc for echoes up to 2 μs . This matches with the sum loss of distribution cable at 100 MHz, 3 dB (Table 15), and an additional 2 dB insertion loss due to other passive elements, such as taps, along the way.

Based on the above observations, we make the following very conservative estimate of loss per 0.5 μs increment in micro-reflection delay at 2 GHz and 3 GHz.

- At 2 GHz, distribution cable loss ~10 dB + 2 dB other insertion losses for other passive giving total of = 12 dB loss/0.5 μs
- At 3 GHz, ~13 dB (trunk) + 2 dB (other) = 15 dB

This leads to the following modified micro-reflection mask at 2 GHz and 3 GHz.

Table 16: Coax Channel Model at 2 GHz and 3 GHz

| Echo Delay | DOCSIS 3.1 Downstream | 2 GHz | 3 GHz |
|------------------------|-----------------------|---------|---------|
| $\leq 0.5 \mu\text{s}$ | -20 dBc | -20 dBc | -20 dBc |
| $\leq 1.0 \mu\text{s}$ | -25 dBc | -32 dBc | -35 dBc |
| $\leq 1.5 \mu\text{s}$ | -30 dBc | -44 dBc | -50 dBc |
| $> 2.0 \mu\text{s}$ | -35 dBc | -56 dBc | -65 dBc |
| $> 3.0 \mu\text{s}$ | -40 dBc | | |
| $> 4.0 \mu\text{s}$ | -45 dBc | | |
| $> 5.0 \mu\text{s}$ | -50 dBc | | |

Using distribution cable data for the micro-reflection mask (upper bound) here is well justified as this gives the worst-case echoes, leading to a reliable if not pessimistic micro-reflection mask. The calculations here need to be validated using real HFC network measurements as part of network characterization for 3GHz DOCSIS.

This indicates channel impulse response delay spread for significant echoes, i.e., stronger than (Target_MER+10 dB), for signal in extended spectrum could be significantly smaller compared to lower frequencies.

18.3. Cyclic Prefix for OFDM

The OFDM cyclic prefix length (guard interval) needs to be long enough to prevent any significant performance degradation due to micro-reflections. To achieve this objective, the delay spread for all significant echoes needs to be smaller than the cyclic prefix with enough margin for transmitter and receiver windowing. The time margin needed for windowing can be significantly reduced or eliminated altogether for extended spectrum as we are dealing with a clean part of spectrum with no legacy channels. For example, by forcing all OFDM channels in extended spectrum to have the same OFDM parameters and synchronizing their timing and frequency, we can eliminate any leakage between OFDM channels without a need for any windowing. For the following analysis we assume there is no windowing.

Given a target MER of 35 dB for extended spectrum, we can aim for a target carrier-to-interference ratio (CIR), which is based on the sum of inter-symbol interference (ISI) and inter-carrier interference (ICI) level, of 50 dB for individual echoes. The idea is to keep aggregate ISI + ICI impact of all echoes outside of the guard interval to be below -45 dBc (i.e., only 0.4 dB impact on 35 dB MER point).

The micro-reflection masks given in Table 16 shows echoes above 2 μs are not relevant for added ESD spectrum as echo amplitudes are well below the -50 dBc threshold. We can restrict this even further because only the portion of echo outside the guard interval contribute to ISI and ICI. More precisely, for an echo longer than the guard interval, the ICI+ISI contribution is given by,

$$ICI_ISI = A_{dB} + 3 + 10 * \log_{10}((\tau - T_g)/T_u) \quad (7)$$

Where A_{dB} is the echo power, τ echo delay, T_g is guard interval and T_u is OFDM useful symbol duration.

For example, a -40 dBc echo that is 1 μs longer than the cyclic prefix in the 20 μs OFDM case causes ISI + ICI = -50 dBc.

We have two downstream OFDM modes within the DOCSIS 3.1 192 MHz channel,

- 8K mode: Symbol length 40 μ s
- 4K mode: Symbol length 20 μ s

Furthermore, we have five cyclic prefix lengths, 5 μ s, 3.75 μ s, 2.5 μ s, 1.25 μ s, and shortest of which is 0.9375 μ s (192 samples at 204.8 MHz). Given the significant reduction in echo levels in extended spectrum, it could be beneficial to introduce shorter CP lengths for 3 GHz ESD. Potential efficiency gains from a reduced cyclic prefix are shown in Figure 16 for the current 4K and 8K OFDM modes and a hypothetical (potential new) 2K OFDM mode.

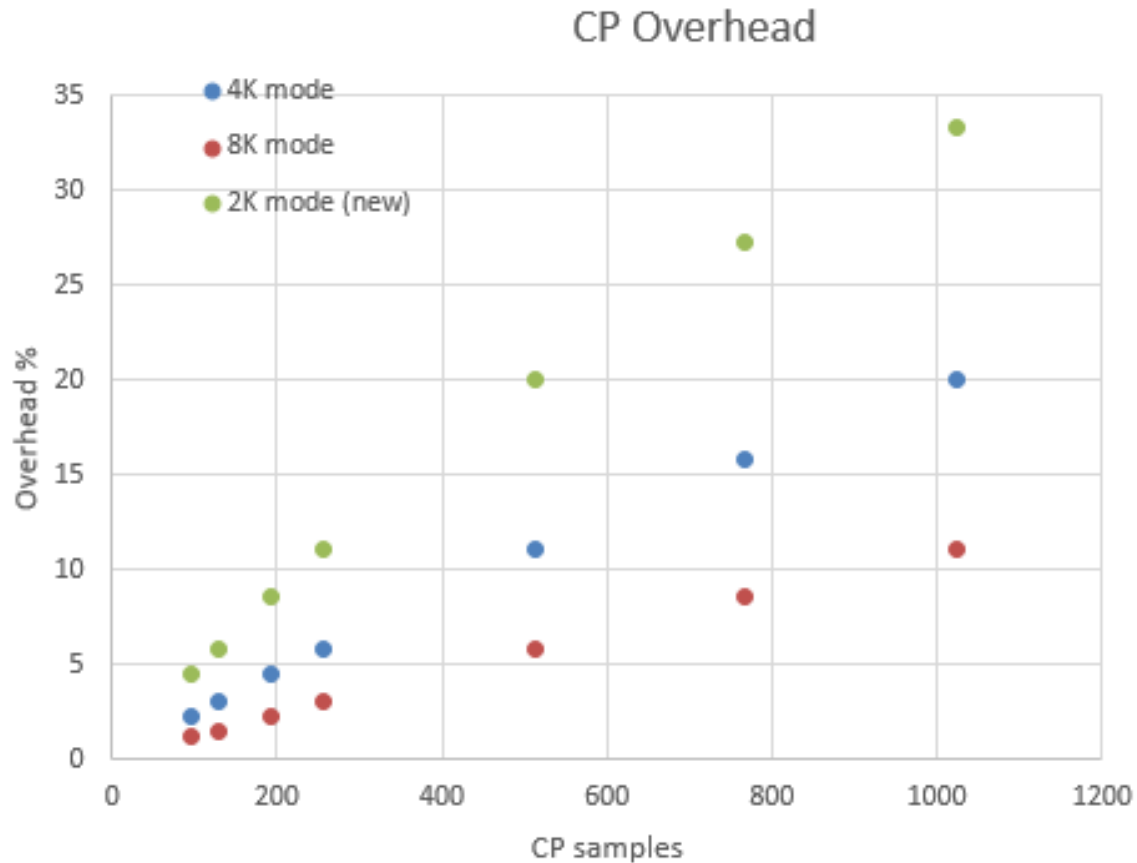

Figure 27: Cyclic Prefix Overhead

The shortest cyclic prefix in DOCSIS 3.1 is 0.9375 μ s. We should consider introducing shorter CP lengths to improve efficiency for ESD. However, a new 2K mode is not a good idea from an efficiency point of view.

18.4. OFDM Symbol Length

Recall that we have two OFDM modes for a DOCSIS 3.1 channel, giving two OFDM symbol length options:

- 8K mode: Symbol length 40 μ s -> subcarrier spacing of 25 kHz
- 4K mode: Symbol length 20 μ s -> subcarrier spacing of 50 kHz

Factors we need to consider in optimizing OFDM symbol length

- **Latency:** Longer symbols gives rise to longer latency. With new applications such as 5G front haul, we may want to optimize latency as much as possible. However, the lion’s share of latency comes not from PHY, but due to scheduling related delays (buffering, etc.). We’d like to keep symbol length shorter, but the current choices of symbol lengths are good enough for this purpose.
- **Time variations in overall channel:** Variations here include outside plant time variations due to factors such as temperature as well as variations internal to transceivers, such as phase noise, AGC variations, etc. We’d like to keep symbol lengths shorter. This is analyzed in the following sections.
- **Efficiency:** We need to make OFDM symbols as long as possible to reduce cyclic prefix overhead. As discussed previously, current OFDM symbols lengths offer acceptable efficiency with the required cyclic prefix lengths. There is further room for efficiency gains in 3 GHz ESD by introducing shorter cyclic prefix options.
- **Frequency resolution for bit loading:** Bit loading frequency resolution should be good enough to follow the frequency dependent SNR of a DOCSIS channel due to amplitude tilt and frequency selectivity of multipath channel. This is likely to be in the order of 100’s of kHz if not more. Current frequency resolution of 50 kHz and 25 kHz offered by 4K and 8K OFDMs are more than enough to enable optimal bit loading to closely fit the SNR profile across ESD Spectrum.

18.5. OFDM Time variations

Based on limited studies in the FDX workgroup, the outside plant variations occur in time scale of seconds. These are too slow to impact decision on OFDM symbol length.

As for variations inside transceivers, phase noise is a major factor. We need phase noise variations within an OFDM symbol to be contained. This is because any variations within the OFDM symbol leads to inter-carrier-interference. It is desirable to keep ICI due to phase noise 10-15 dB below the MER target to limit the impact on performance.

The DOCSIS 3.1 specification [1] mandates that the CMTS adheres to the following clock jitter requirements for the downstream OFDM symbol clock jitter mask over the specified frequency ranges as shown in Table 17:

Table 17: CMTS RMS Jitter Spec

| Frequency Range | RMS Jitter | Equivalent phase noise referred to f_{DS} - SSBError! Bookmark not defined. ¹ |
|----------------------------|------------|--|
| 10 Hz to 100 Hz | < 0.07 ns | -21+20*log(f_{DS} /204.8) dBc |
| 100 Hz to 1 kHz | < 0.07 ns | -21+20*log(f_{DS} /204.8) dBc |
| 1 kHz to 10 kHz | < 0.07 ns | -21+20*log(f_{DS} /204.8) dBc |
| 10 kHz to 100 kHz | < 0.5 ns | -4+20*log(f_{DS} /204.8) dBc |
| 100 kHz to (f_{DS} /2), | < 1 ns | 2+20*log(f_{DS} /204.8) dBc |

¹ Equivalent phase noise = $20\log_{10}(RMS_Jitter \times 2\pi f_{DS})$ dBc

In addition to meeting the above clock jitter requirements, the CMTS is required to meet the following phase noise requirements [1] as shown in Table 18.

Table 18: CMTS Phase Noise mask at 1002 MHz

| Frequency Range | Integrated Phase Noise (@1002 MHz) -SSB |
|------------------|---|
| 1 kHz - 10 kHz | -48 dBc |
| 10 kHz - 100 kHz | -56 dBc |
| 100 kHz - 1 MHz | -60 dBc |
| 1 MHz - 10 MHz | -54 dBc |
| 10 MHz - 100 MHz | -60 dBc |

In the event of a conflict between the clock jitter and the phase noise requirement, the CMTS MUST meet the more stringent requirement [1]. Based on above rule, we can define a combined time jitter phase noise PSD for the CMTS @1218 MHz. This is shown in Table 19.

Table 19: Combined Phase Noise Mask for CMTS

| Frequency Range | Integrated Phase Noise (@1002 MHz) - SSB |
|-------------------|--|
| 10 Hz to 100 Hz | -7.2 dBc |
| 100 Hz to 1 kHz | -7.2 dBc |
| 1 kHz to 10 kHz | -48 dBc |
| 10 kHz to 100 kHz | -56 dBc |
| 100 kHz to 1 MHz | -60 dBc |
| 1 MHz to 10 MHz | -54 dBc |
| 10 MHz to 100 MHz | -60 dBc |

Given double sideband (DSB phase noise PSD $\Phi(f)$), the integrated phase noise in $f_1 \text{ Hz} - f_2 \text{ Hz}$ range is given by $\int_{f_1}^{f_2} 2\Phi(f) df$. CMTS phase noise below 1 kHz is perhaps too relaxed. In Figure 28, let's look at the DOCSIS 3.1 phase noise profile with the phase noise below 1 kHz represented with -10 dB/decade tilt.

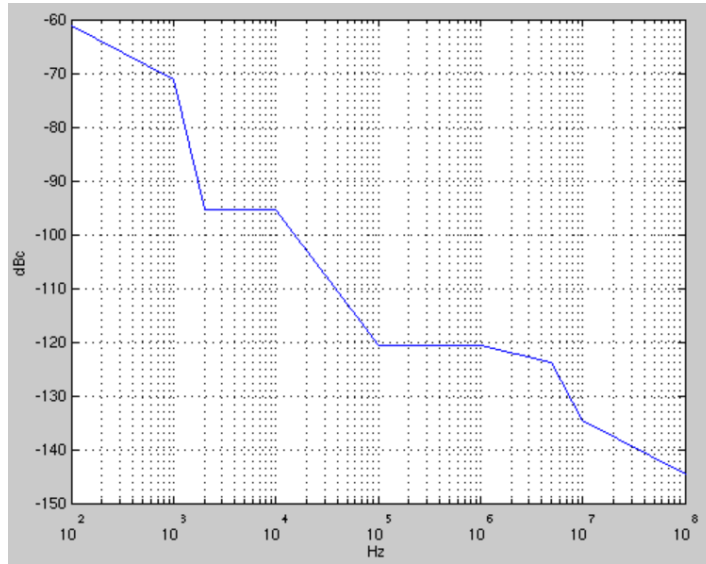

```
Int_Pha_Power (10 Hz to 100 Hz) -Inf dB
Int_Pha_Power (100 Hz to 1 kHz) -33.777828 dB
Int_Pha_Power (1 kHz to 10 kHz) -44.668151 dB
Int_Pha_Power (10 kHz to 100 kHz) -54.262065 dB
Int_Pha_Power (100 kHz to 1 MHz) -58.151684 dB
Int_Pha_Power (1 MHz to 10 MHz) -52.337972 dB
Int_Pha_Power (10 MHz to 100 MHz) -58.071943 dB
```

```
ICI_mid = 49.693168 dB, ICI_edge = 52.682889 dB
CPE power = 6.031562e-04 radians radians, RMS C
ICI power <= 100 Hz = 90.112047 dB
ICI power <=kHz = 72.709654 dB
ICI power kHz - 10kHz = 68.517150 dB
ICI power 10kHz - 100kHz = 61.384878 dB
ICI power 100kHz - MHz = 61.167415 dB
ICI power MHz - 10MHz = 55.348498 dB
ICI power 10MHz - 100MHz = 61.082261 dB
ICI power 1kHz - 100MHz = 52.732882 dB
```

Figure 28: CMTS Phase Noise PSD – DSB, referred to 1218 MHz

The impact of phase noise on OFDM can be worked out using the method described in [5]. RMS common phase error (CPE) for OFDM symbol with subcarrier spacing $f_u = 1/T_u$ and number of subcarriers N is given by,

$$RMS_CPE = \sqrt{\int_0^{Nf_u/2} 2 \operatorname{sinc}^2\left(\frac{f}{f_u}\right) \Phi(f) df} \quad (8)$$

CPE introduces the same phase rotation to all subcarriers. Digital demodulation can correct for CPE. This can be done accurately in DOCSIS with available continuous pilots. For example, using the minimum of 8 boosted power (by 6 dB) continuous pilots, we can estimate CPE with an accuracy of $6+10 \cdot \log_{10}(8) = 15$ dB below the noise floor.

Inter-carrier interference to signal ratio (ICI/S) for edge and middle subcarrier of OFDM symbol is given in below [5].

| | |
|---|---|
| Mid Subcarrier | Edge Subcarrier |
| $\int_0^{Nf_u/2} 2 \left(1 - \operatorname{sinc}^2\left(\frac{f}{f_u}\right)\right) \Phi(f) df$ | $\int_0^{Nf_u} \left(1 - \operatorname{sinc}^2\left(\frac{f}{f_u}\right)\right) \Phi(f) df \quad (9)$ |

ICI can also be corrected to a certain degree [9][10] with advanced signal processing techniques. However, it is desirable to keep the ICI level well below quasi error free (QEF) noise floor, if possible, to keep demodulator complexity in check.

ICI due to CMTS phase noise profile analyzed here is given in Table 20.

Table 20: ICI/dBc ratio in dB due to CMTS Phase Noise from Figure 28

| Upper Edge | 25 kHz Subcarrier (8K mode) | | 50 kHz Subcarrier (4K mode) | | 100 kHz Subcarrier (2K mode) | |
|------------|-----------------------------|--------------|-----------------------------|--------------|------------------------------|--------------|
| | Middle Carrier | Edge Carrier | Middle Carrier | Edge Carrier | Middle Carrier | Edge Carrier |
| 500 | 56.5 | 59.5 | 57.4 | 60.4 | 57.9 | 60.9 |
| 1218 | 48.8 | 51.8 | 49.7 | 52.7 | 50.2 | 53.2 |
| 2000 | 44.5 | 47.5 | 45.5 | 48.4 | 45.9 | 48.9 |
| 3000 | 41.0 | 44.0 | 41.9 | 44.9 | 42.4 | 45.4 |

ICI for 8K mode is only 0.9 dB worse than 4K mode because of broad phase noise PSD compared to subcarrier spacing. The hypothetical 2K mode is only 0.5 dB better.

CMTS ICI numbers are not good enough for us to have 15 dB margin over target MER (40 dB at lower frequencies to 30 dB at higher frequencies) given in Figure 26. We need about 5 dB improvement. In practice, the phase noise profiles are better than what is given in the specifications and in this regard, the DOCSIS PHY specification needs updating.

Going for a new shorter symbol length (2K OFDM mode) to ease the phase noise spec is not justifiable as it does not give enough improvement in ICI levels and ends up costing in efficiency as explained in the cyclic prefix discussion. Non-performance related reasons, such as to reduce number of subcarriers to lower memory requirements, etc., could be considered in the spec process.

19. Conclusion

In conclusion, DOCSIS 3.1 OFDM symbol lengths, 20 μ s and 40 μ s, look like good candidates for 3 GHz ESD. New shorter cyclic prefix options could be considered to further improve efficiency. We could also reduce RX and TX window length by using synchronized OFDM channels – i.e., no ICI/leakage between channels. The impact of potential external interferers also needs to be considered. This potentially opens possibility for very small CP lengths leading to improved OFDM efficiency.

Node and CM phase noise specs need to be reassessed for 3 GHz ESD and improve in line with what is possible with technology.

OFDM channel bandwidth choice has little to do with PHY performance. We can get to any reasonable bandwidth by changing the number of subcarriers, for instance, double the number of subcarriers to get to twice the existing DOCSIS 3.1 maximum channel bandwidth, to 384 MHz. Unless there is a good argument for doing this, we recommend keeping the maximum channel bandwidth as it is now in DOCSIS 3.1: 192MHz.

Power Amplifier Circuit Design Development

20. Output Stage Gain Blocks for HFC Amplifiers and Nodes

The performance and specifically the linear output power of the output stage gain blocks, the so-called power doublers (PD) inside cable amplifiers and nodes for HFC networks, have a substantial impact on the design of such system architectures. Therefore, to define new network systems, it is required to understand the linear output capability of cable amplifiers and nodes by characterizing the output stage gain blocks for their specific capabilities under the required loadings. On top of this, it needs to be considered that there is about 2 dB to 3.5 dB of loss between the output stage gain block and the amplifier or node housing output.

In the past, new semiconductor technologies enabled new generations of systems with higher bandwidth and higher output capability. Figure 29 shows the efficiency of the output stage gain block as it developed and increased over time while introducing new semiconductor technologies and circuit designs. For example, in the 1990s the introduction of gallium arsenide (GaAs) semiconductor technology to replace silicon (Si) bipolar transistors significantly increased the linear output power of the output stage gain block and therefore the efficiency of the power amplifier. About 10 years later, another semiconductor technology enabled even better efficiencies and higher linear output power with the combination of GaAs and gallium nitride (GaN) process technology in one gain block.

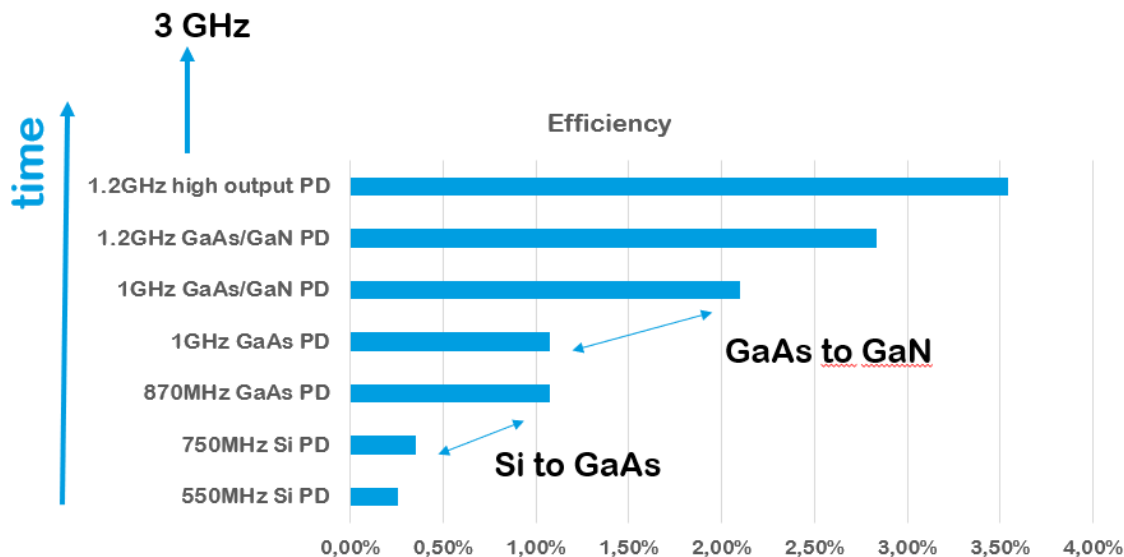

Figure 29: Efficiency Development of Output Stage Gain Blocks in so-called Power Doublers

Since then, this combination of semiconductor technologies was further developed and optimized to provide higher bandwidth with the expansion to 1.2 GHz systems and additional higher linear output power.

50 MHz to 1.2 GHz gain blocks are state of the art today. There is some hardware available for systems up to 3 GHz or even higher, but this is limited to single-ended devices that are intended to be used as

drivers. Such products are not capable of supporting the required performance for output stage gain blocks. 3 GHz hardware output stage gain blocks are not available as of today.

To start, defining a new 3 GHz HFC network systems requires a detailed perform system simulation. To support this, output stage gain block models had to be developed that can be used to perform multi-carrier linearity simulations that then can be used to understand the limitations of the power amplifiers in 3 GHz systems.

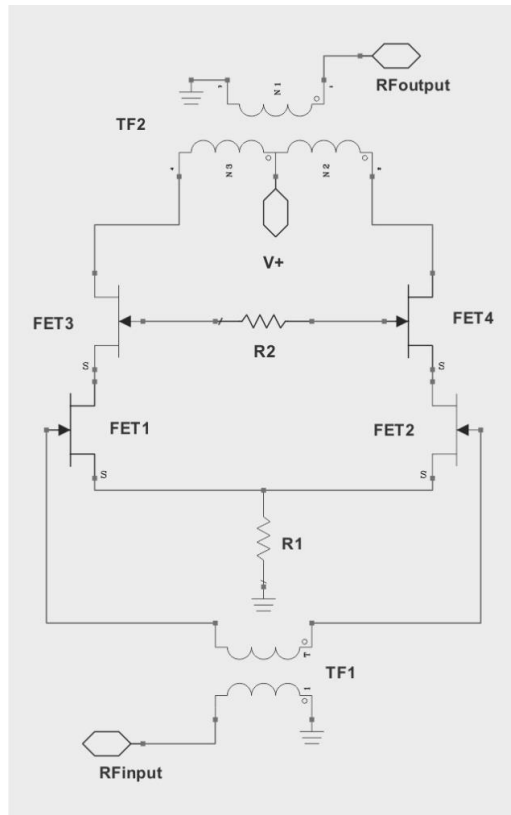

Figure 30: Simplified model schematic of balanced design in cascode configuration employing GaAs semiconductor technology for FET1 and FET2 and GaN for FET3 and FET4

finally defines the linear output power of the gain block. Baluns and transformers (TF) (see TF1 and TF2 in Figure 31) are used to convert the balanced circuit to single ended input and output ports and to match the transistor circuit to 75 ohms.

21. 3 GHz Output Stage Gain Block Simulation Model

To extend the bandwidth from today's standard 1.2 GHz to 3 GHz, it is essential to investigate the RF properties and performance of the employed semiconductor technology. Specifically, for the GaN based top devices of the cascode, various available process technologies were modeled and characterized to

Historically, output stage gain blocks employ balanced designs in cascode configuration. The balanced design ensures that even mode distortion products are canceled and that linear output power is primarily dependent on odd mode distortion products. The cascode configuration enables the multi-octave bandwidth required for cable networks systems.

Figure 31 shows a simplified schematic of a balanced design in cascode configuration employing GaAs pseudomorphic high electron mobility transistor (pHEMT) technology for the cascode bottom device (see field effect transistor 1 (FET1) and FET2 in Figure 31) and GaN high electron mobility transistor (HEMT) semiconductor technology for the cascode top device (see FET3 and FET4 in Figure 31).

During the development of a 3 GHz gain block model and the performed simulations, it was again confirmed that the described balanced design in cascode configuration provides the best performance in respect to bandwidth and linear output power.

The ability to combine various semiconductor technologies into one gain block offers the possibility to select the technology that provides the best properties for each stage in the gain block. GaAs pHEMT provides high transconductance and high f_T to enable high gain and a wide bandwidth for the amplifier.

The high breakdown and power density capabilities of GaN technology supports the required high voltage swing that

understand the capabilities and limitations for this application. Historically, GaN based gain blocks used in cable amplifiers primarily employed 0.5 μm or 0.25 μm gate length GaN processes. To accommodate the higher frequencies requirements for 3 GHz applications, Qorvo’s GaN process GAN15ES was selected for the model. The GAN15ES GaN HEMT process comes with a 0.15 μm gate length enabling high frequency applications even in the mm-wave frequency range today.

To derive an exact gain block model, special non-linear models for the GaN stage were generated by taking load pull data from actual GAN15ES FET devices at the specific bias and frequency conditions applying for this application. This non-linear model was then used to develop and optimize the output stage gain block model.

The developed model of the gain block provides a bandwidth of 50 MHz to 3 GHz, with 19 dB gain at 100 MHz and 21 dB gain at 3 GHz. The bias condition was selected to be $V^+ = 32\text{ V}$ and $IDC = 560\text{ mA}$ to achieve the highest linear output power with this configuration.

To simulate the linear performance of gain blocks today, the simulation benches with two-tone tests like second order intercept point (IP2) or third order intercept point (IP3) are used in most cases. These simulation results can be used to optimize the gain block for linearity, and measurements results can be correlated with the simulation results once the amplifier is taped out, processed and finally measured. However, the two-tone tests provide only an indication about the broadband linearity performance under multi-carrier loadings. There is no strong correlation between two-tone tests and multi-carrier distortion tests.

For a 3 GHz network system, it is not sufficient to perform two-tone tests only for the simulations. Therefore, it was required to develop a simulation bench that can apply a multi-carrier or broadband input signal to the gain block model and to analyze the output of the gain block for distortion products generated by the gain block.

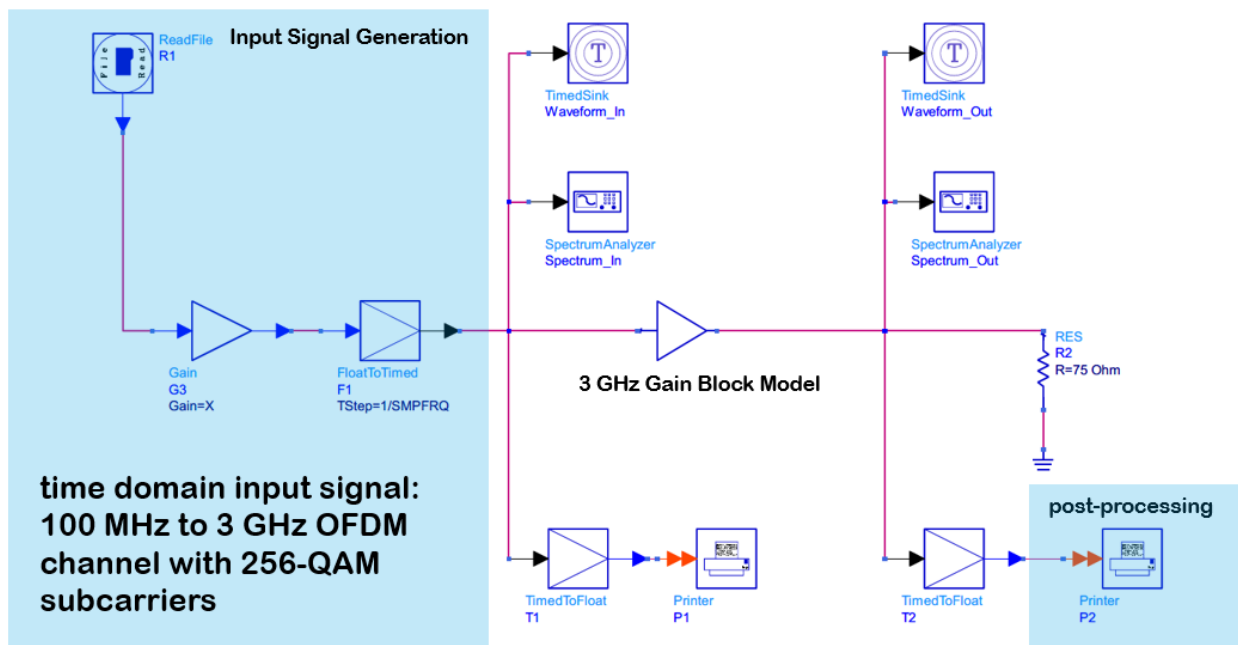

Figure 31: Multi-carrier distortion simulation test bench

Figure 31 shows the simulation bench that was used to simulate the distortion performance and the linear output capability of the developed output stage gain block model. For the input signal, a 100 MHz to 3 GHz OFDM channel with 256 state quadrature amplitude modulation (256-QAM) subcarriers was selected that is also used for 3 GHz network system simulations. This time domain input signal is converted into the RF domain and applied to the gain block model to perform the non-linear large signal simulation of the gain block. Input and output signals are monitored in the time and RF domain for external post-processing to derive MER data over frequency and level.

It is specifically challenging to make sure such simulations converge and provide results when applying a wideband large signal to a gain block model. It required several iterations of semiconductor models and circuits design model updates to finally successfully complete the non-linear simulations.

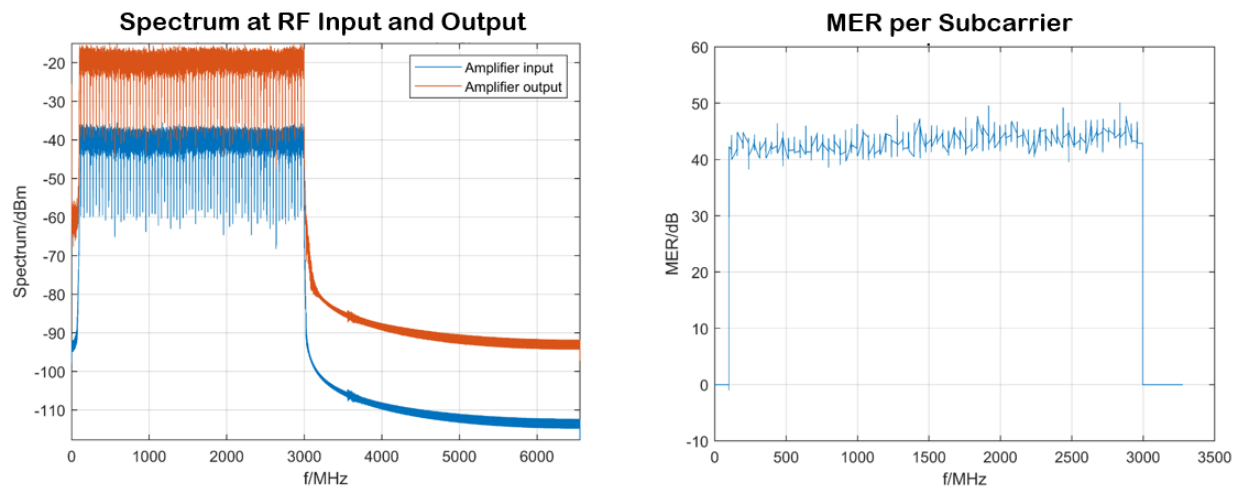

Figure 32: Simulation RF input and output spectrum and the MER per subcarrier over frequency

Today, the exact shape of the signals, levels and split between upstream and downstream is not yet specified for future 3 GHz network systems. The intention of this simulation task, however, is to derive an idea about the linear output power or (TCP) that can be achieved with currently available semiconductor technology. Therefore, a full loading between 50 MHz and 3 GHz with no tilt was selected, applied to the gain block model and characterized for MER over frequency as shown in Figure 32.

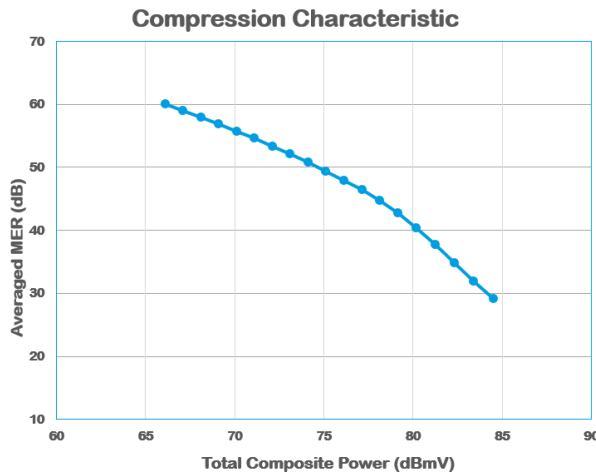

Figure 33: Simulated compression characteristic of averaged MER versus TCP

This is the simulation results for a specific input and therefore the output level (TCP = 57.6 dBmV RF input and TCP = 78.2 dbmV RF output). The output signal derived from the simulation was post-processed and resulted in an average MER of 45 dB. Additionally, the simulations showed that the MER versus frequency signature basically follow the input and output signal shape.

To understand the gain block characteristic at various loading levels, the previously described input signal was swept and an MER compression curve was simulated. Figure 34 shows the averaged MER over the output level (TCP). The gain block model provides a linear degradation of MER of about 1 dB per 1 dB increase in level up to a TCP of 77 dBmV. Above 78 dBmV, the gain block is compressing with more than 2 dB MER degradation per 1 dB increase in level. Also, MER drops below 40 dB MER above 80 dBmV TCP.

This linear output power capability basically matches the performance that can be measured on state of the art 1.2 GHz output stage gain blocks under DOCSIS 3.1 loadings. The compression characteristic results derived from the simulation were used for further HFC network system simulation to design and define the future system architecture.

22. Conclusion

A 3 GHz output stage gain block model was developed and characterized for averaged MER versus output TCP. Similar linear output power was achieved as with measurements on state of the art 1.2 GHz output stage gain blocks. Therefore, the performed simulation tasks proved that semiconductor technologies available today are capable of supporting 3 GHz gain block developments for 3 GHz HFC applications with respect to bandwidth and linearity. Future investigations have to characterize the performance of the gain blocks when the exact shape of the loading and the split between the upstream and downstream is defined.

Additional Deployment Considerations

This technology will not be available all at once. This is a likely 1.8 GHz upgrade phase that will happen prior to the 3 GHz upgrade phase. In addition, the upgrade for any increased spectrum impact the both the HFC and the DOCSIS equipment, so a joint upgrade has to occur. Specifically, an upgrade for 1.8 GHz and/or 3 GHz impacts:

1. The CM
2. Passive splitters in the home network or HFC plant
3. Taps
4. Amps
5. Nodes
6. RPD
7. CMTS Core

That is a lot of coordination required. Some practical interim steps could help speed time to market. Most deployed taps in the field will not get to 1.8 GHz due to the pin seizure design. This white paper looked at a redesign of the pin seizure that allowed that tap to extend its performance to 3 GHz. As such, all tap upgrades should be 3 GHz to allow for future planning, even if the near-term plant usage is 1.8 GHz.

If or when the node/amp/line extender housing are upgraded for extended spectrum, they should be 3 GHz capable even though the initial electronics may only be 1.8 GHz capable. The CM could be designed with a 3 GHz front end, but only have enough OFDM channels to support 10 Gbps. CMs could be frequency stacked.

Summary

This white paper discussed in detail how to move from the 1.2 GHz systems of today that are capable of 10 Gbps in the downstream to a 3 GHz system that is capable of 25 Gbps in the downstream. This would match the speed of fiber, either competitively, or fiber that is used in a DAA architecture to backhaul a DAA node.

The paper discussed how extended spectrum required either more power, less modulation, or less distance between actives. The proposal in this paper was for less distance between actives but only for the extended spectrum. This was achieved by putting one or two 3 GHz extended spectrum amplifiers (ESA) between existing amps. If the ESA was co-located with a tap, that would be a hybrid active tap (HAT). Between the legacy spectrum and the extended spectrum, there would be an extended spectrum transition band (ETB) for the diplexers in the HAT.

The power that is used to operate the extended spectrum is less than the legacy spectrum as there are more amps with less power per amp. If the transition band is moved down, the power to run the legacy spectrum is also reduced. It may be possible to take enough power from the legacy band and use it to run the extended band without increasing the overall plant power. This was referred to as the Robin Hood scheme.

There are many different spectrum plans that could be used. This paper looked at four 3 GHz plans

1. *Premium plan* with 1218 MHz ETB with extended FDX (not defined yet). This could support 25 Gbps downstream and 10 Gbps upstream.
2. *MoCA plan* with 1100 MHz ETB. The ETB is chosen to align with the MOCA band.
3. *Legacy plan* with 1002/862/750 ETB. The ETB would line up with previous older generations of plant.
4. *Lowest power plan* with a 684 MHz cross-over. This is the maximum Robin Hood scheme.

This was compared to DOCSIS 3.1 at 1.218 GHz and DOCSIS 4.0 at 1.8 GHz which are both 10 Gbps downstream systems.

Amplifier tilt is another design consideration. Tilt is needed to match the increase attenuation at high frequencies. If the amplifier components in the node, amps, and line extenders are full spectrum, then they will need a common tilt. However, if the RPD feeding the node came out at different flat power levels at different frequencies, then less power could be put into the extended band where the ESA exists. If there are separate amps for legacy and extended spectrum, then the tilt values could be different. The final specification may have separate power rules for below 1.218 GHz, 1.218 GHz to 1.8 GHz and 1.8 GHz to 3.0 GHz.

The PHY may require some tweaking to get to 3 GHz. There may be an impact to the cyclic prefix for efficiency. Phase noise is much harder at 3 GHz than at 1.2 GHz by a factor of 9. Finally, a complete silicon simulation was performed to prove that a 3 GHz amplifier component could be built.

Acknowledgements

The authors would like to thank Shaul Shulman and Rainer Strobel from Intel and Nguyenvu Chu from Qorvo for their contributions to this project. We would also like to thank Ron Hranac for his excellent review of our paper.

Abbreviations

| | |
|--------|--|
| bps | bits per second |
| CIR | carrier-to-interference ratio |
| CM | cable modem |
| CP | cyclic prefix |
| CPE | common phase error |
| DOCSIS | Data-Over-Cable Service Interface Specifications |
| DPA | distributed power amplification |
| DS | downstream |
| DSB | double sideband |
| ESA | extended spectrum amplifier |
| ESD | extended spectrum DOCSIS |
| ETB | extended spectrum transition band |
| FDX | full-duplex |
| FEC | forward error correction |
| FET | field effect transistor |
| fT | transition frequency |
| FTB | full duplex transition band |
| GaAs | gallium arsenide |
| GaN | gallium nitride |
| HAT | hybrid active tap |
| HEMT | high electron mobility transistor |
| HFC | hybrid fiber/coax |
| Hz | hertz |
| dBmV | decibel millivolt |
| ICI | inter-carrier interference |
| ICI/S | inter-carrier interference to signal ratio |
| IDC | DC current |
| IP2 | second order intercept point |
| IP3 | third order intercept point |
| ISBE | International Society of Broadband Experts |
| ISI | inter-symbol interference |
| OFDM | orthogonal frequency division multiplexing |
| PA | power amplifier |
| PD | power doubler |
| pHEMT | pseudomorphic high electron mobility transistor |
| PoE | point of entry |
| PSD | power spectral density |
| MER | modulation error ratio |
| QAM | quadrature amplitude modulation |
| QEF | quasi error free |
| RGB | reduced guard band |
| SCTE | Society of Cable Telecommunications Engineers |
| Si | silicon |
| TCP | total composite power |
| TF | transformer |
| US | upstream |

Bibliography & References

- [1] *MoCA 2.0 Specification for Device RF Characteristics*, MoCA Alliance, April 6, 2015
- [2] *SCTE 235 2017: Operational Practice for the Coexistence of DOCSIS 3.1 Signals and MoCA Signals in the Home Environment*, SCTE, 2017
- [3] *MoCA 2.0/2.5 Specification for Device RF Characteristics*, MoCA Alliance, August 8, 2016
- [4] *Data-Over-Cable Service Interface Specifications DOCSIS® 4.0*, CableLabs, Physical Layer Specification, CM-SP-PHYv4.0-D01-190628
- [5] Rainer Strobel, *Channel Modeling and Physical Layer Optimization in Copper Line Networks*, Springer, 2019
- [6] Bingham, A. C., *Multicarrier modulation for data transmission: an idea whose time has come*, IEEE Communications magazine, May 1990
- [7] Sahin, A., et al. *A Survey on multicarrier communications: prototype filters, lattice structures, and implementation aspects*, July 2013
- [8] Stott, J., *The effect of phase noise in COFDM*, BBC Research and Development
- [9] Hewavithana Thushara, et al., *Method and apparatus for phase noise mitigation*, US Patent 8897412
- [10] Hewavithana Thushara, et al., *Computationally Efficient Algorithm for Mitigating Phase Noise in OFDM Receivers*, US Patent 10171272
- [11] *HFC network measurements*, CableLabs, 2017
- [12] *FDX Channel Models From Fiber Deep Designs*, Comcast, 2017