

# Applying Impedance Tuning to Maximize Antenna Performance in 5G Phones

By Abhinay Kuchikulla  
Senior Marketing Manager, Mobile Products

## Abstract

RF complexity in mobile phones continues to increase rapidly with the advent of 5G, making it even more difficult for phone manufacturers to meet stringent performance requirements. As phones include more antennas and support more frequency bands, it becomes increasingly challenging to maintain antenna performance across all usage conditions and frequencies. Impedance tuners help to solve the problem by maximizing RF power transfer under different conditions and across multiple frequency bands. As a result, they are increasingly being used to optimize performance, reduce design cost and meet 5G requirements. This white paper describes how impedance tuners can be used and discusses the relative advantages of different impedance tuner designs. It includes several examples that demonstrate how impedance tuning can be used to achieve significant performance improvements in typical real-world scenarios.

## Introduction

RF complexity in mobile phones has increased exponentially over the past few years, and 5G is creating yet another complex layer in mobile device design. This complexity makes it even more difficult to meet performance requirements, especially given the limited space allocated to RF technology in mobile devices.

Maximizing antenna performance is one of the key challenges. Phone manufacturers are adding more antennas to handle the growing number of frequency bands and wireless standards. As more antennas are crowded into the phone, their performance becomes more susceptible to external conditions, such as the phone's proximity to different materials and the way a user might hold their phone. The antenna impedance can change under these conditions, causing an impedance mismatch between the antenna and RF front end (RFFE). The antenna impedance also changes as the antenna communicates on different frequency bands. Impedance mismatch reduces RF power transfer between the RFFE and antenna, which impacts the phone's RF performance overall and reduces battery life because transmit power must be increased to compensate for the losses.

Impedance tuners address this problem by matching the impedance of the antenna to the impedance of the RFFE under different use conditions and across a range of frequencies. This maximizes the RF power transferred between the RFFE and antenna, helping smartphone manufacturers meet performance requirements for different use cases and a wide range of frequency bands.

## The Problem: Impedance Mismatch Between RFFE and Antenna

The RFFE impedance is generally a constant  $50\Omega$ , but the antenna impedance varies depending on the frequency band and use case conditions. When there is an impedance mismatch, the result is a reduction in the RF power transferred between the RFFE and the antenna. When the phone is transmitting, for example, not all the available power from the source (RFFE) is delivered to the load (antenna), which can cause signal loss of up to several dB.

The amount of loss depends on the size of the mismatch between the impedances of the RFFE and the antenna. Figure 1 shows the loss in the system under different VSWR (voltage standing wave ratio) conditions.

Figure 1: Comparison of VSWR and impedance loss.

VSWR	Loss
1:1	0 dB
2:1	0.51 dB
3:1	1.25 dB
6:1	3.1 dB
10:1	4.81 dB
20:1	7.41 dB

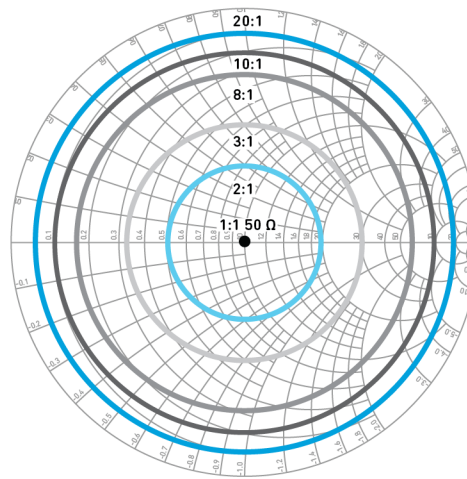

© Qorvo, Inc.

There are two types of change to antenna impedance: static and dynamic.

### Static Change in Antenna Impedance with Frequency

The amount of variation will depend on the antenna design. The impedance changes as the antenna communicates on different bands, and the impedance may also vary within different regions of the same band. Figure 2 shows an antenna that is matched at 1900 MHz; the impedance changes at other frequencies, causing losses due to impedance mismatch.

Figure 2: Impedance changes as frequency changes.

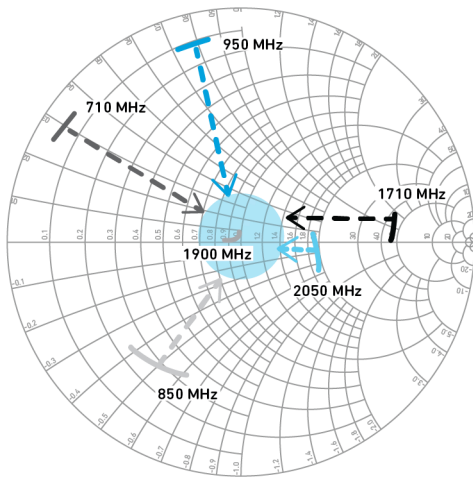

© Qorvo, Inc.

### ***Dynamic Change in Antenna Impedance in Different Use Case Conditions***

The antenna impedance can also change dynamically depending on how the phone is held and whether it is near other objects. The primary antennas on a typical mobile phone are located at the bottom and top of the phone. In phones with metal shells, a significant portion of the antenna is located on the outside of the phone to maximize performance. In conventional use case conditions, such as when the phone is resting on a desk, held vertically or used in a traditional audio conversation, these antennas are not blocked and thus performance is maximized. In some conditions, however, proximity to different materials can cause the impedance of the antenna to change, thus reducing antenna efficiency and increasing losses within the phone. In severe conditions, such as when the phone is held in a landscape position where both hands block the antennas, the antenna impedance changes significantly.

Figure 3: The positioning of the phone changes the antenna impedance.

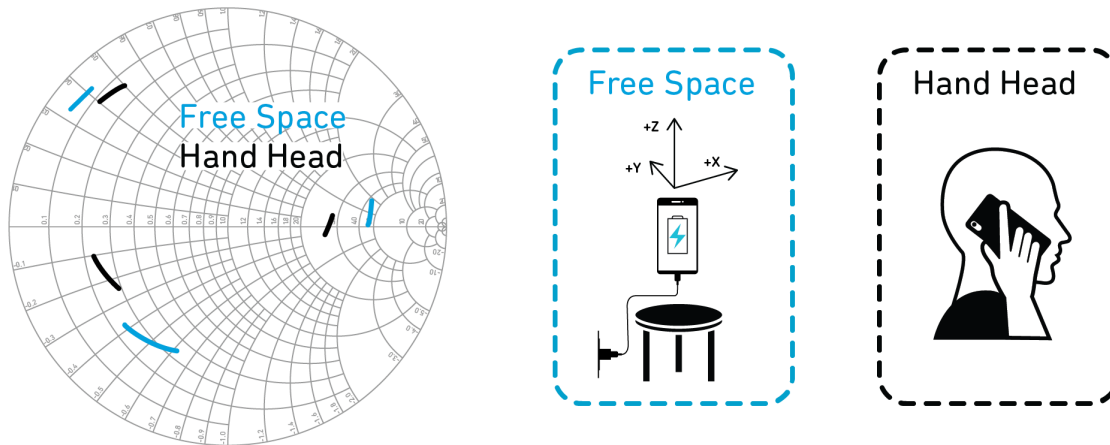

© Qorvo, Inc.

## Solving the Impedance Mismatch Problem

The solution to the impedance mismatch problem is to insert an impedance matching network between the RFFE and the antenna to maximize the power transfer between the antenna and RFFE.

In accordance with the maximum power transfer theorem, the source delivers maximum power to the load when the load impedance is a complex conjugate of the source impedance (or to put it another way, the maximum amount of power will be delivered to the load resistance when the load resistance is equal to the Thevenin/Norton resistance of the network supplying the power).

Thus, to maximize power transfer from the RFFE to the antenna, an RFFE with a  $50\Omega$  source needs to see an antenna impedance of  $50\Omega$ . However, while the RFFE impedance is generally constant at  $50\Omega$  across all bands, the antenna impedance varies with frequency and use case conditions. To align these two impedances, it is necessary to use impedance matching between the RFFE and antenna.

## What is an Impedance Matching Network?

An impedance matching network is a circuit typically comprised of inductors and capacitors that is used to match the impedance of the antenna to the RFFE over the required frequency range.

Figure 4: Impedance comparison with/without impedance matching.

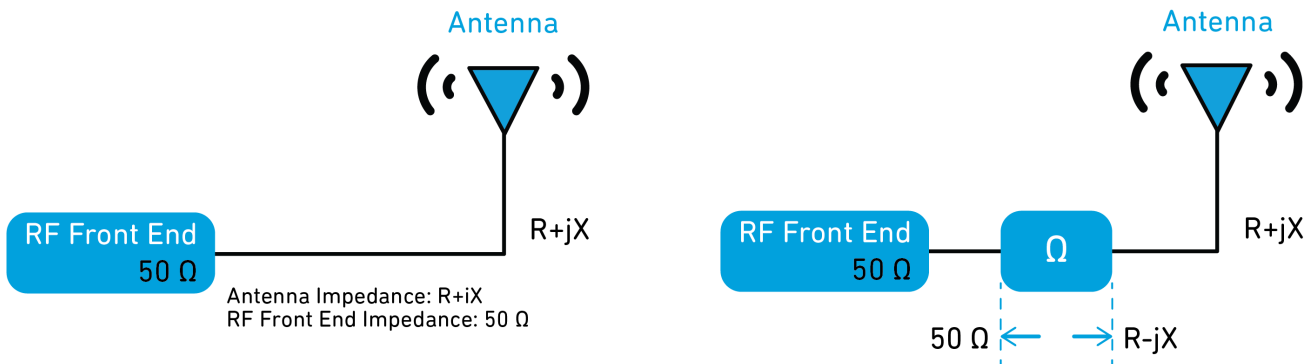

© Qorvo, Inc.

The impedance matching network shown above provides a  $50\Omega$  impedance to the RFFE, thus providing the complex conjugate impedance of the RFFE to the antenna. Inductors and capacitors are typically used for impedance matching networks in mobile phones because the resulting networks have relatively low loss and enable maximum power transfer. Transmission lines and transformers can also be used for matching but are not optimum for matching mobile phone antennas.

### Limitations of a Fixed Matching Network

If the matching network is made up of only fixed inductors and fixed capacitors, then the matching capability of the network is limited to fixed impedances. Because the impedance of the antenna changes with frequency and use case conditions, the fixed impedance coverage limits optimum matching to only a few frequency bands and sometimes only a single use case condition.

### Benefits of a Tunable Matching Network

A tunable matching network on the other hand, enables matching to a much wider impedance range. A tunable matching network is comprised of inductors and capacitors that can be tuned to different values.

Figure 5 illustrates the advantages of a tunable capacitor over a fixed capacitor. The goal is to add impedance matching for a source VSWR of 6:1 and phase of  $45^\circ$ . Adding a fixed  $1.9\text{ pF}$  series capacitor in series between the source and load enables maximum power transfer at  $830\text{ MHz}$ , as it provides a conjugate match between the source and the load at that frequency. But as shown in Figure 6, a fixed  $1.9\text{ pF}$  series capacitor does not provide a conjugate match at other frequencies.

Figure 5: Comparison of fixed and tunable capacitance matching.

Impedance Matching to 6:1 & 45°

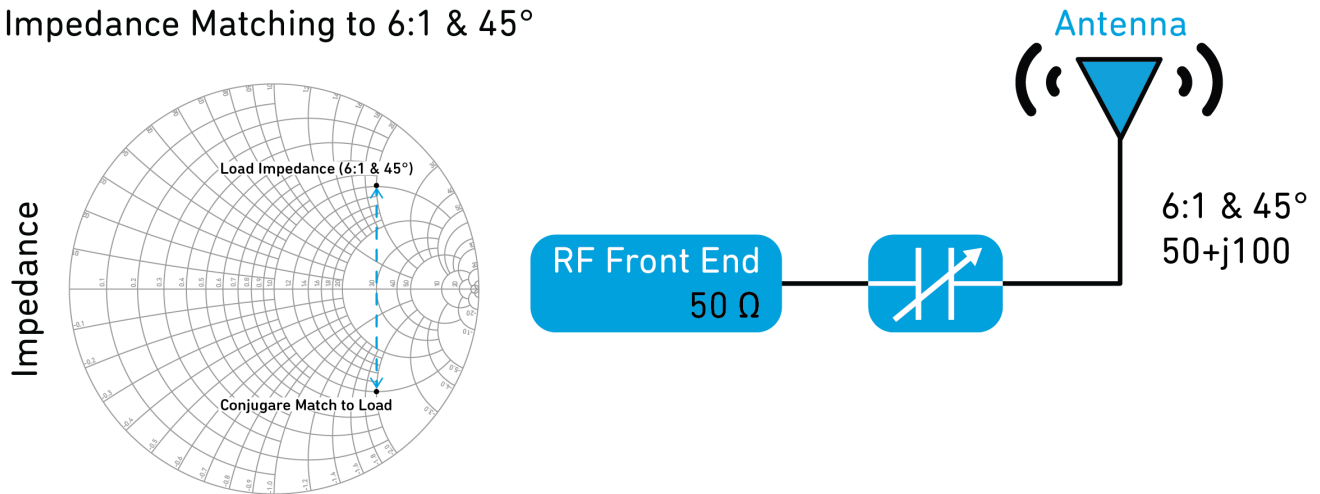

© Qorvo, Inc.

Figure 6: Capacitance required by frequency for 6:1 VSWR and 45 phase.

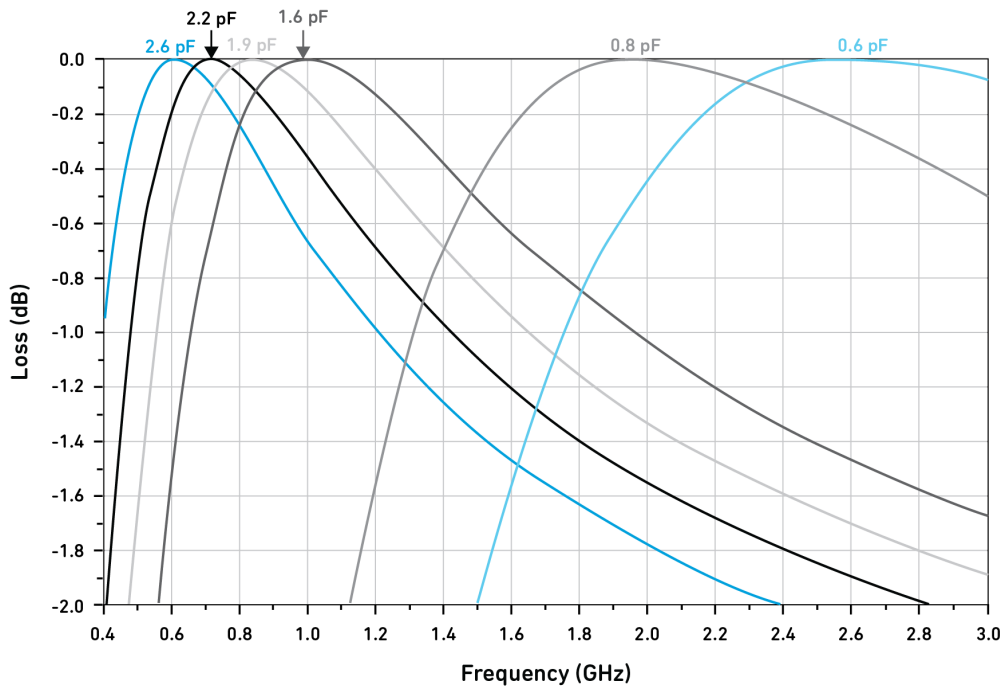

© Qorvo, Inc.

In contrast, a tunable capacitor with a range of 0.6 pF to 2.6 pF would be able to provide complex conjugate matching to the load over a very wide frequency range, enabling maximum power transfer across multiple frequency bands.

### ***Choosing the Right Metric to Quantify the Benefit of a Tunable Matching Network***

It's important to use the correct metric to quantify the advantages of a tunable matching network, because some commonly used metrics such as return loss don't measure how much a matching network increases the power delivered to the load. Return loss is the ratio of the incident power to the power reflected by the load. If there is no matching network between the source and the load, it can be assumed that a reduction in reflected power from the load means that more power is being delivered to the load. For example, a return loss of 10 dB means 90% of the power will be delivered from the source to the load. However, if a matching network is used to help match the source impedance to the load impedance, the return loss is not the best metric to judge the amount of power delivered to the load. This is especially important when using a tunable matching network. For example, the tunable matching network may be configured to a lossy state, so some of the power from the source is dissipated in the matching network. This reduces the reflected power and therefore the return loss, but it doesn't mean that more power is delivered to the load.

A better metric in this case would be transducer power gain. This is defined as:

$$\text{Transducer Gain (dB)} = 10\log\left(\frac{\text{Power delivered}}{\text{Power available}}\right)$$

A perfectly matched and lossless system would have a transducer gain of 0dB. However, achieving a transducer gain of 0 dB is not a realistic goal in practice, because it's difficult to achieve a perfect match across a wide frequency range and because there will be some loss in any system.

### ***The Difficulty of Achieving a Perfect Match Across the Frequency Range***

The changes in antenna impedance with frequency make it difficult to match to the antenna to its complex conjugate across a wide frequency range. For example, in a typical FDD system, the antenna is transmitting and receiving simultaneously but at two different frequencies, which are separated due to isolation requirements. Figure 7 below shows how the antenna impedance differs between transmit and receive frequencies for bands 5 and 1.

Figure 7: Band 5 and band 1 transmit and receive impedances.

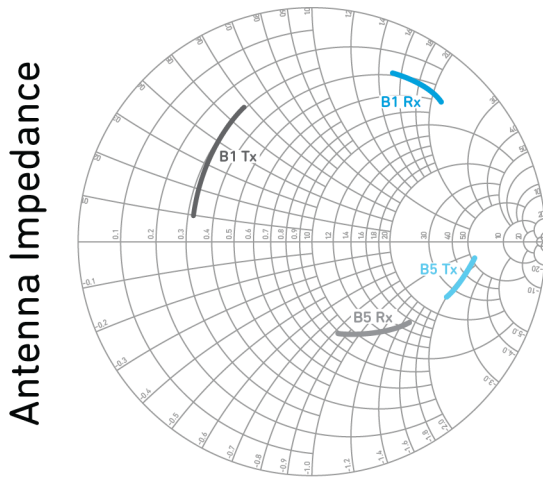

© Qorvo, Inc.

### ***Inherent Losses***

Because the capacitors and inductors that make up the matching network are lossy, the matching network is lossy overall. Adding more elements to the matching network increases the insertion loss due to the loss in the components and the accompanying increase in PC board parasitics.

It is possible to minimize the loss using capacitors and inductors with higher quality (Q) factors, but higher-Q elements are generally bigger and more expensive.

In most cases, it is not necessary to perfectly match the source to the load. A VSWR of 2:1 or even 3:1 is acceptable. A VSWR of 2:1 will result in 89% of the power being delivered and a VSWR of 3:1 will result in 75% of the power being delivered.



## Tuner Gain as a Metric for Impedance Matching Networks

Rather than focusing solely on insertion loss, a better metric for the effectiveness of the impedance matching network is tuner gain. Tuner gain is the ratio of transducer gain with and without an impedance tuning network. It is becoming the most commonly used metric for quantifying and comparing the benefit of impedance matching networks. A network that is perfectly matched to a VSWR of 3:1 will have a tuner gain of 1.25 dB.

The tuner gain metric takes into account both the gain and loss at the antenna, with and without the matching network. A simple network can provide limited matching with very low loss, whereas a complicated network may provide excellent matching but with a higher amount of loss. Using the tuner gain measurement helps to find the right balance between impedance tuner loss and the network output. Tuner gain can be directly correlated to the improvement in total antenna efficiency.

## Building Impedance Matching Networks with Tunable Capacitors and Inductors

Tunable capacitors and inductors are the optimum approach for creating matching networks with broad impedance coverage. A network with the ability to tune both capacitors and inductors makes it possible to adjust impedance in multiple directions, as shown in the Smith charts in Figure 8.

Figure 8: Tunable capacitor and inductor Smith chart impedance coverage.

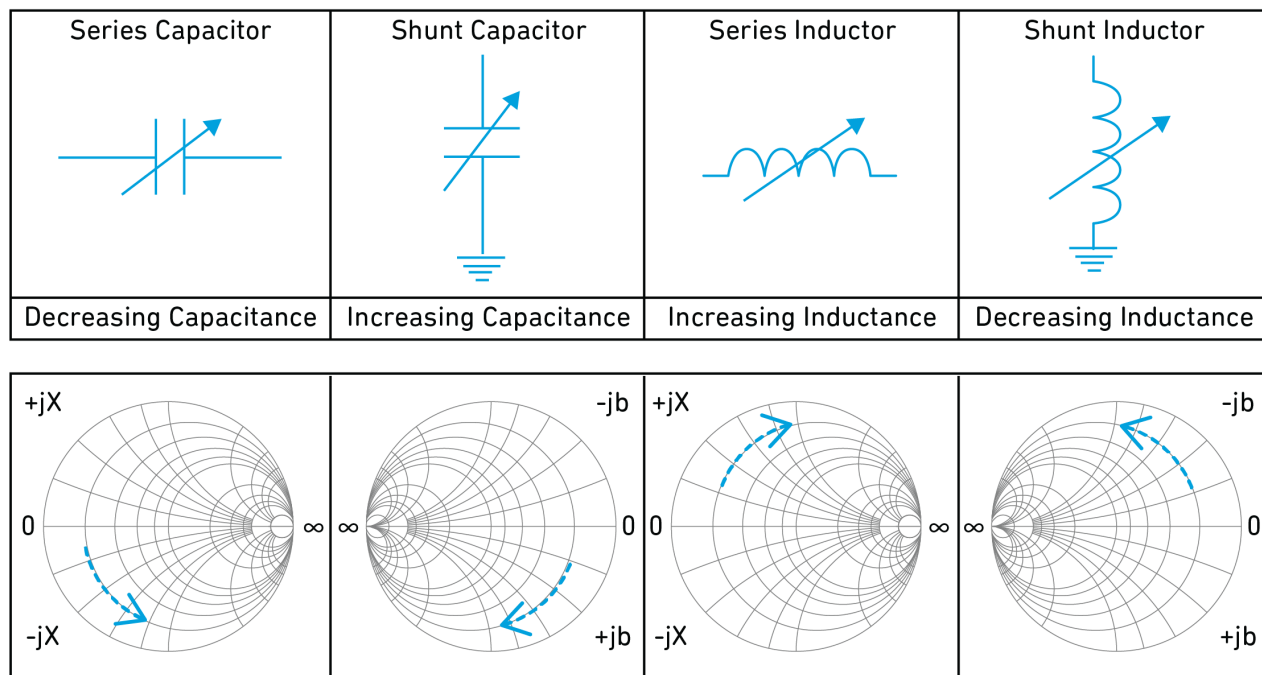

## Comparing Different Types of Matching Networks

Increasing the number of matching elements provides even greater Smith chart coverage. Figure 9 compares the same tunable capacitor used in three types of matching networks: on its own, in a L-match design together with an inductor and in a Pi-match design with two inductors.

- A simple tunable capacitor ( $C_s$ ) in series has limited tuning capability, with maximum benefit in the inductive region and negative impact in the capacitive region.
- Adding a shunt inductor ( $L_a$ ) vastly improves the tuning capability in the capacitive region.
- Adding another inductor ( $L_s$ ) at the input of the Pi matching network enables tuner gain to be maintained at a relatively flat level across both the inductive and capacitive regions.

However, note that while the average tuner gain is improved by increasing the number of tuning elements, the maximum tuner gain is reduced due to the additional losses in these elements.

Figure 9: Comparing tuner gain with different types of matching networks.  
(measurements are shown for 6:1 VSWR at 915 MHz)

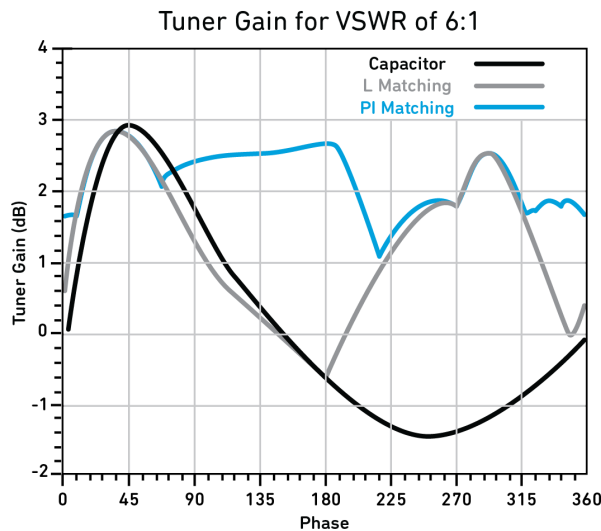
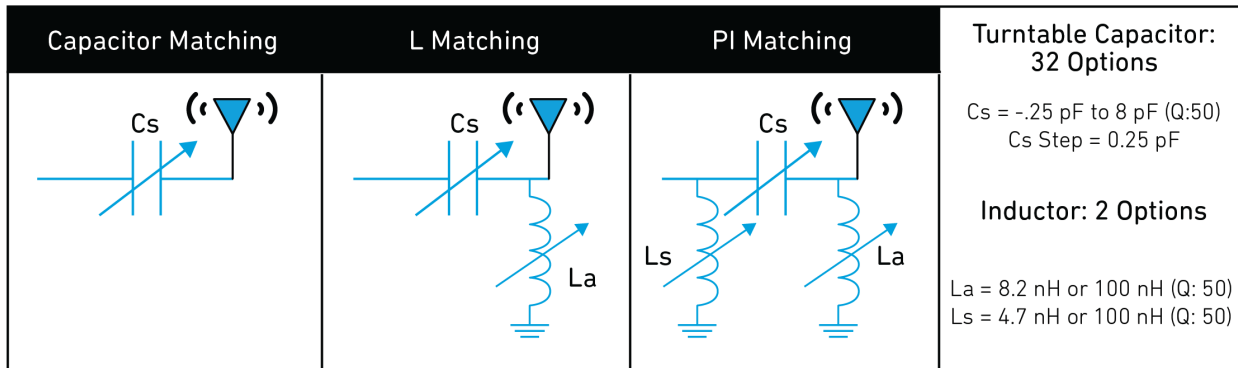

Average Tuner Gain (0°-360°)	Capacitor	L Matching	PI Matching
	0.1 dB	1.2 dB	2.2 dB



© Qorvo, Inc.

## Using Switches to Bypass the Matching Network and Enable Inductive Tuning

A key question is, how do you minimize loss when the matching network is not required? One approach is to add a switch to bypass the matching network. The following sections explain the use of switches and show measurements that illustrate advantages.

### Tunable Inductor

Integrated tuning inductors suffer from higher losses and are also typically larger in size. An alternative approach is to combine higher-Q inductors and low-loss switches to create a high-performance tunable inductor, as shown in Figure 10.

Figure 10: Switches for tunable inductor and bypass mode.

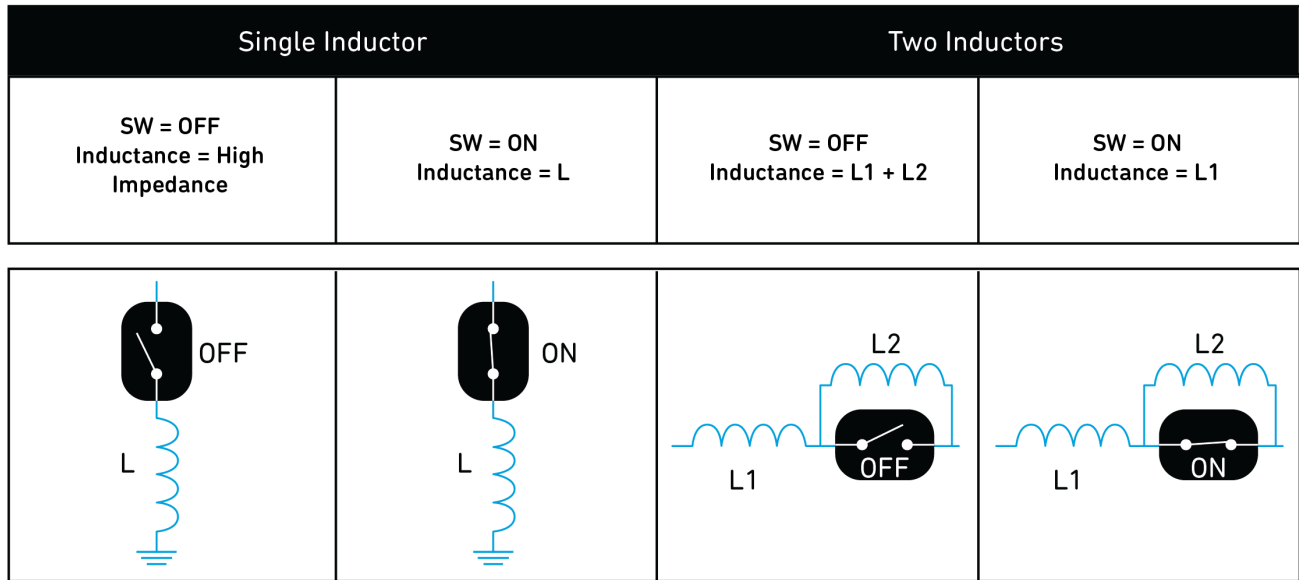

**Bypass Mode**

As shown in Figure 11, switches can also be used to bypass series elements. Consider the example of an antenna whose impedance varies with frequency but is matched to the RFFE at a specific frequency range. In this frequency range, an impedance matching network is not necessary and simply adds additional loss. A switch can be used to bypass the series elements to help minimize the loss when the antenna is operating in this frequency range. Figure 11 shows the difference in tuner gain with and without a bypass switch. The example uses a switch with an insertion loss of 0.2 dB.

Figure 11: Bypass mode switch network measurements.

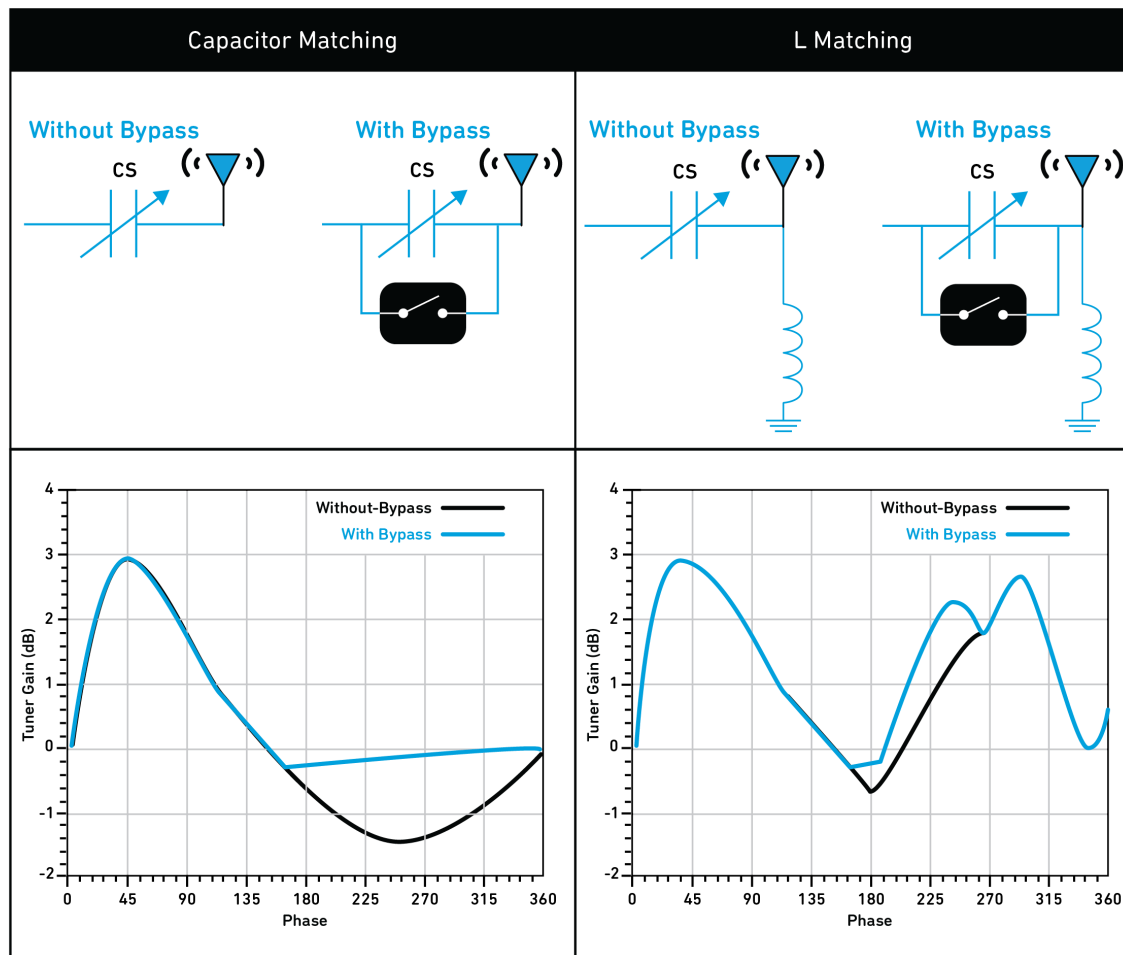
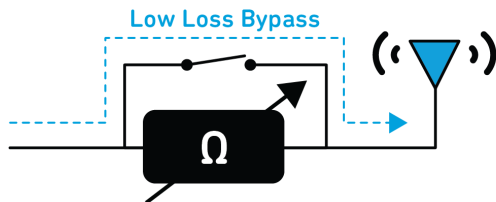

Incorporating a bypass switch can reduce the loss in some regions of the Smith chart. In the case of capacitive matching, a series capacitor is not useful for matching in the capacitive region (180° to 360°) of the Smith Chart.

In this region, the bypass switch can be turned ON to minimize the overall loss in the network.

## Impact of Q on Tuner Gain

How important is the Q factor of the elements used in impedance matching networks? As the following example shows, increasing Q can improve tuner gain – but the improvement starts to saturate to a point. Higher-Q parts also have the disadvantage of being larger, which can cause the overall solution size to increase.

The Q factor of a capacitor or inductor is a metric of the losses in the part. For a capacitor (or inductor), Q is the ratio of reactance to resistance. In an ideal capacitor or inductor, the resistance is zero, thus making Q infinite.

Figure 12: Quality factor tuner gain measurements at various tunes.

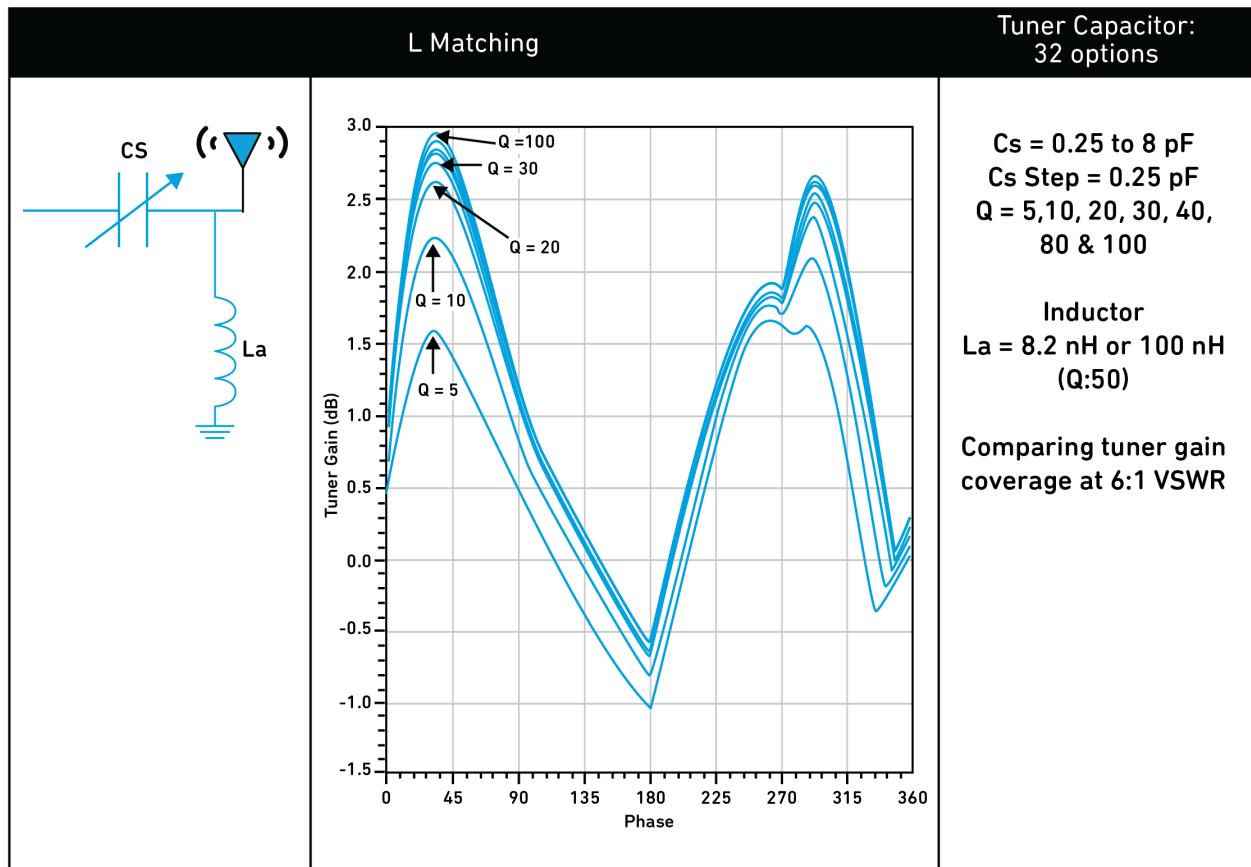

Table 1: Average tuner gain for different networks with capacitor Q varied from 5 to 100.

Q Value Tuner Gain	5	10	20	30	40	50	60	70	80	90	100
Capacitor	-0.4 dB	-0.14 dB	0 dB	0.06 dB	0.09 dB	0.1 dB	0.11 dB	0.12 dB	0.13 dB	0.13 dB	0.14 dB
L Matching	0.51 dB	0.86 dB	1.06 dB	1.13 dB	1.17 dB	1.2 dB	1.21 dB	1.23 dB	1.23 dB	1.24 dB	1.25 dB
PI Matching	0.81 dB	1.4 dB	1.86	2.05 dB	2.14 dB	2.2 dB	2.24 dB	2.27 dB	2.29 dB	2.31 dB	2.32 dB



© Qorvo, Inc.

Figure 12 and Table 1 compare the impact of Q using the same three matching circuits as in the previous example. The Q of the inductors is held constant for all three networks to compare the performance when varying the Q of the tunable capacitor. The tuner gain increases significantly when Q is increased from 5 to 10, and then from 10 to 20. But once Q reaches the 30 to 40 range, further increases in Q produce relatively little performance improvement.

## Examples of Using Impedance Tuners in Real Antenna Problem Scenarios

In this section, we discuss several real-life scenarios in which tunable impedance matching networks can be used to improve total antenna efficiency.

### **Example A: Reducing Loss on Band 5**

Without a tuning network, the loss due to impedance mismatch on band 5 ranges from almost -2.9 dB at the low end of the band to -0.8 dB at the high end of the band.

By adding an L-match tuning network with fixed inductor, majority of loss can be recovered, especially at the low end of the band (Tx), as shown in Figure 13.

Figure 13: Reducing loss on Band 5 using an L-match tuning network with switch.

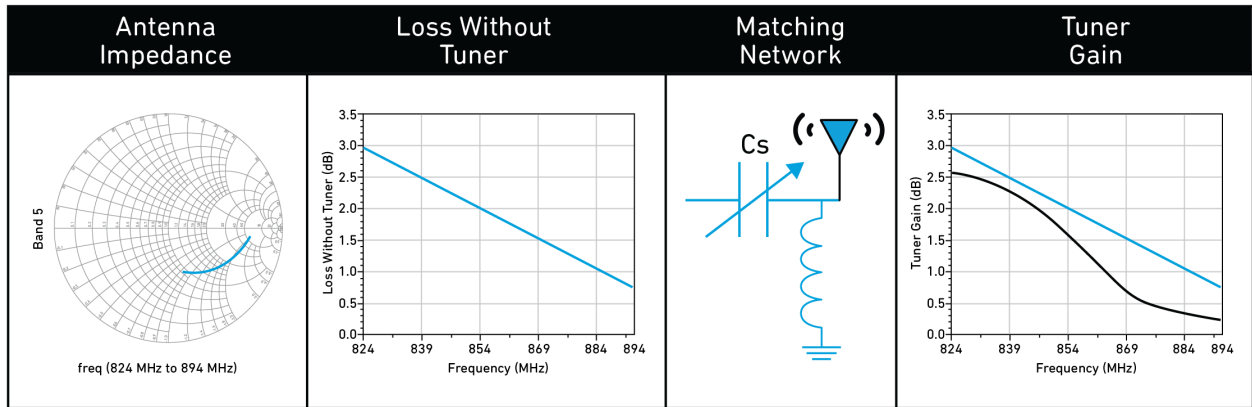

© Qorvo, Inc.

The performance at the higher end of the band (Rx) can be improved further by adding an inductor and switch closer to the antenna, as shown in Figure 14.

Figure 14: Further improving performance on Band 5 with a Pi-match switch tuning network.

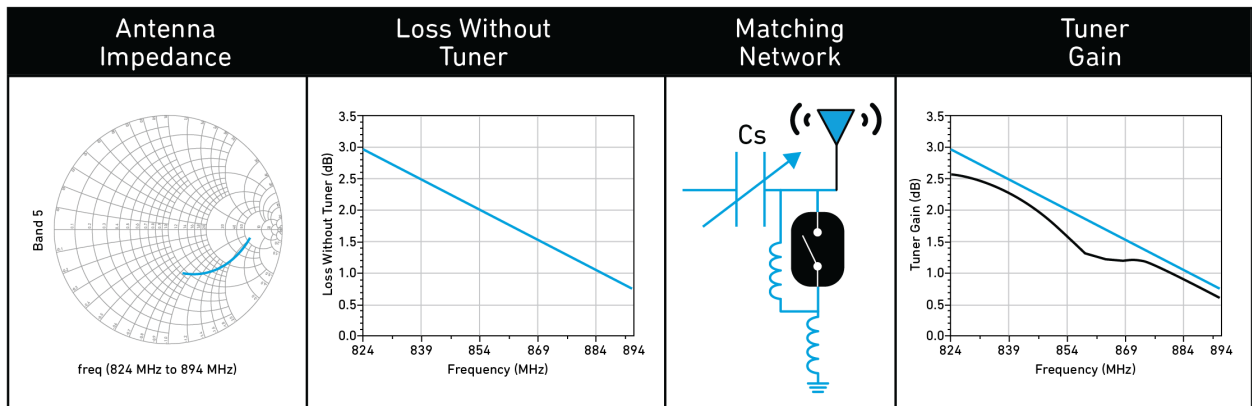

© Qorvo, Inc.

**Example B: Reducing Loss on Band 1**



The loss due to impedance mismatch on band 1 ranges from almost -4.7 dB at the high end of the band to -0.7 dB at the low end of the band.

As the impedance lies mostly in the inductive region of the Smith Chart, a tunable series capacitor is enough to recover most of the mismatch loss.

Figure 15: Improving tuner gain on Band 1 with a tunable capacitor tuning network.

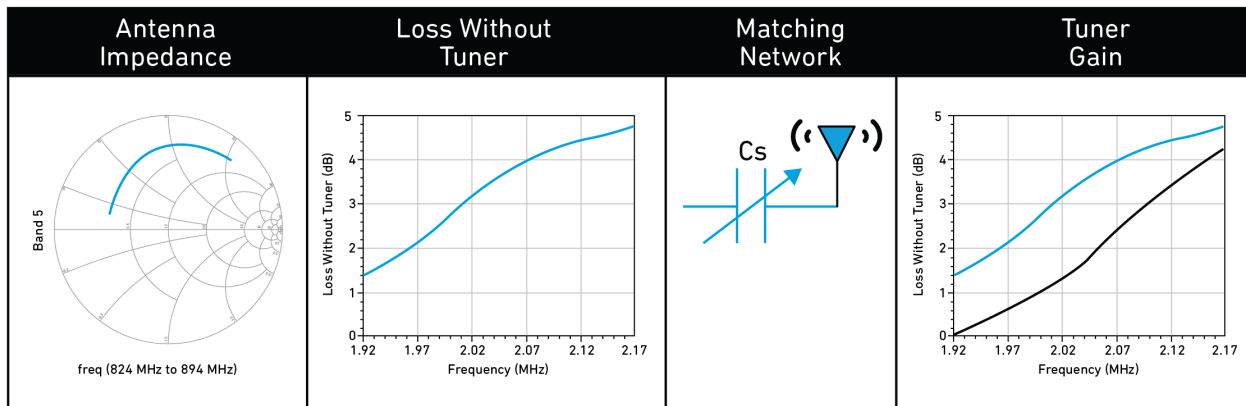

© Qorvo, Inc.

An improvement of almost 1 dB can be achieved at the low end of the band by adding a shunt inductor at the input.

Figure 16: Further improving performance on Band 1 with an L-match switch network.

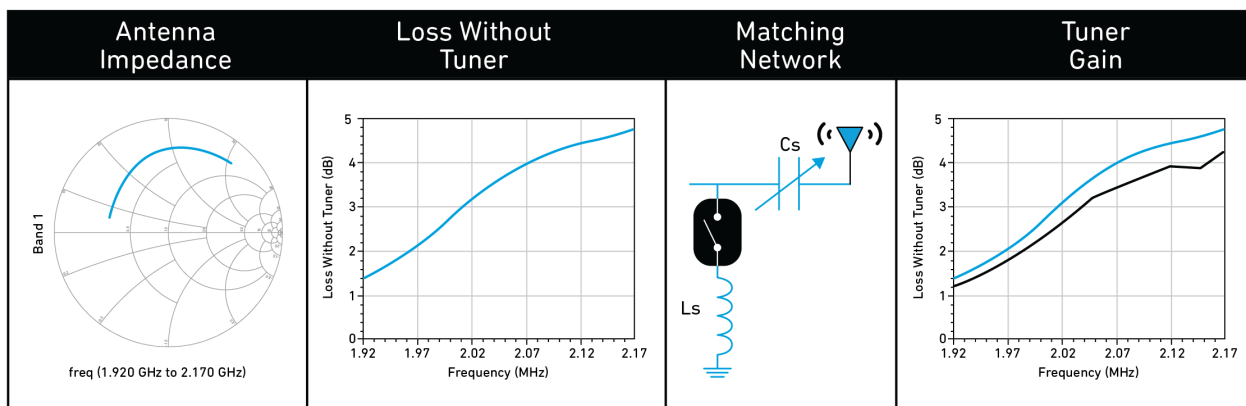

© Qorvo, Inc.

**Example C: Using an Integrated Tuner Module to Improve Performance on Multiple Bands**

In this example, an integrated impedance tuner module is used to improve total antenna efficiency on several bands. Due to poor matching, antenna performance on Bands 12 and 13 was very low, as shown in Figure 17. A tunable L-type matching network was selected to improve performance. The network consisted of a module that integrated a tunable capacitor and single pole single throw switch, along with an external inductor.

Figure 17: Frequency band efficiency measurements for L-match switch network.

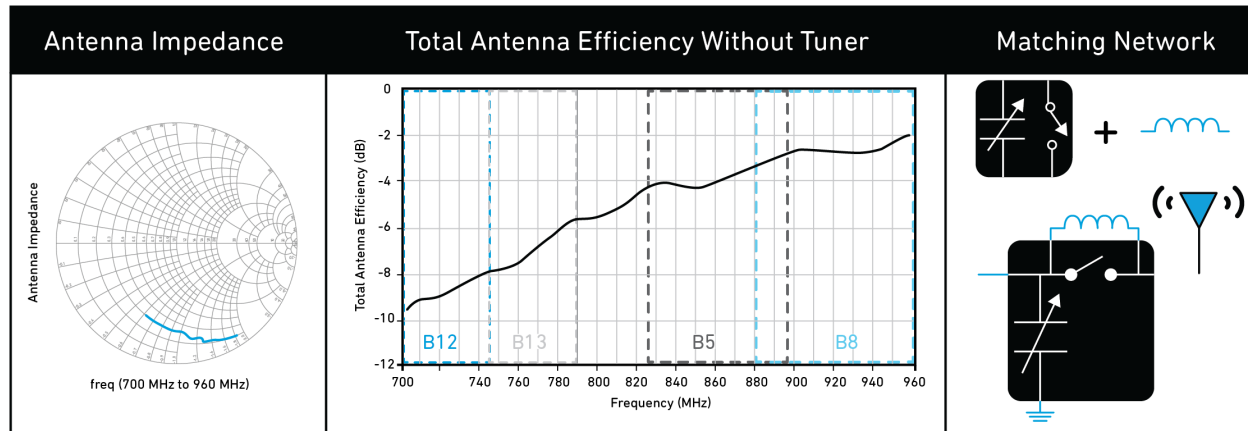

© Qorvo, Inc.

With the impedance matching network, the total antenna efficiency improved significantly in Bands 12 and 13, as shown in Figure 18. There was also considerable improvement in Band 5 and Band 8 Tx. The antenna's total efficiency degraded slightly in Band 8 Rx due to the inability of the L-match network to provide an optimum match at that impedance, and due to loss in the matching network.

Figure 18: Comparison of tuner efficiency with and without tuning network.

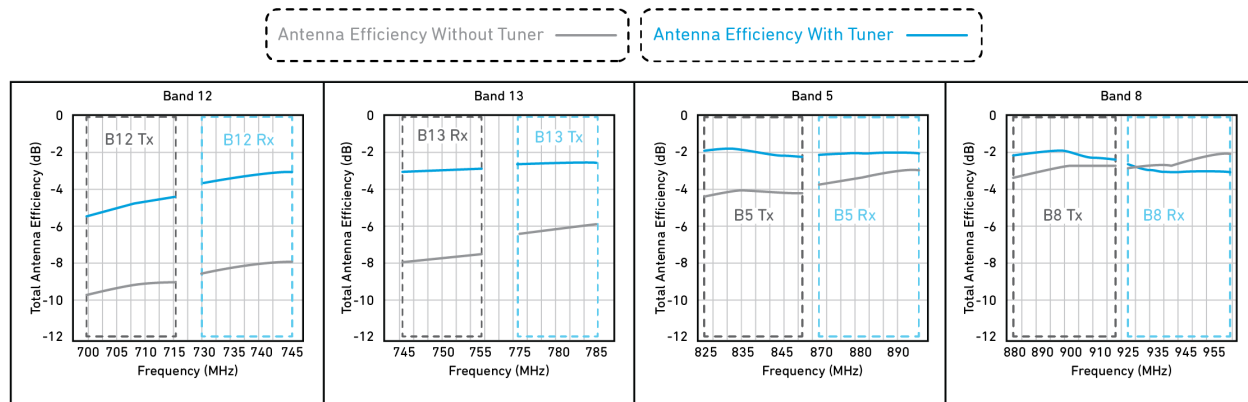

© Qorvo, Inc.

**Example D: Comparing the Advantages and Disadvantages of More Complex Matching Networks**

This example illustrates the advantage and disadvantages of using a more complex matching network that includes more tuning elements.

Figure 19 shows two different matching networks: a relatively simple series capacitor matching network with switch bypass and a more complex Pi matching network.

Figure 19: Comparing tuning matching complexity.

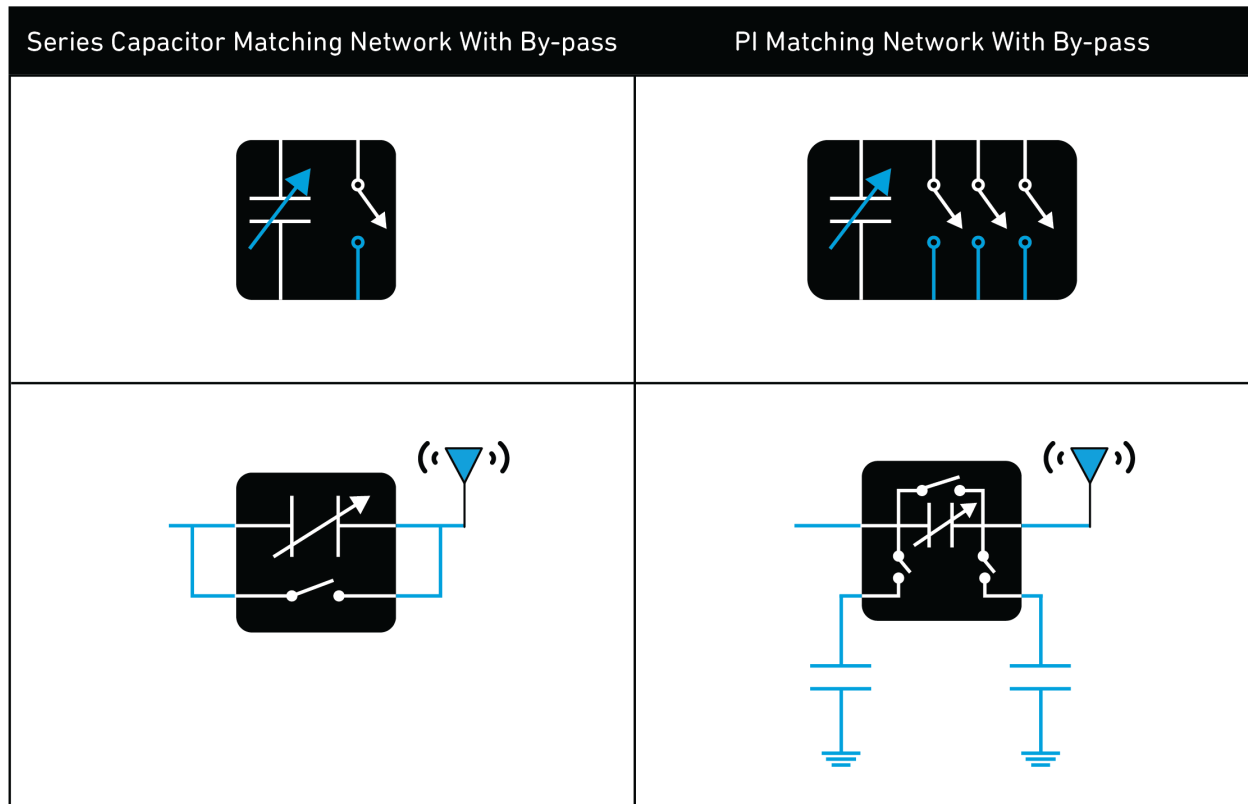

© Qorvo, Inc.

Both matching solutions improve total antenna efficiency at frequencies between 700-750 MHz and >820 MHz, as shown in Figure 20. The improvement is significant at the edges.

However, the antenna is already very well matched between 750 MHz and 820 MHz, without the matching network, the loss in this region is primarily due to radiation efficiency of the antenna. Using the matching network when the antenna is operating in this region will simply increase the loss. Therefore, to minimize the loss, both networks use a bypass switch.

Overall, the antenna efficiency is better with a Pi-match network when compared to simple series capacitor matching. By adding two shunt switches and shunt capacitors on either side of the series capacitor, the match to the antenna can be improved significantly between 880 MHz to 960 MHz (Band 8). However, the inclusion of these two switches and capacitors causes a higher amount of loss when they are not in use, as seen in two regions (700-720 MHz and 800-820 MHz) in the example below.

Figure 20: Comparing antenna efficiency with different matching networks.

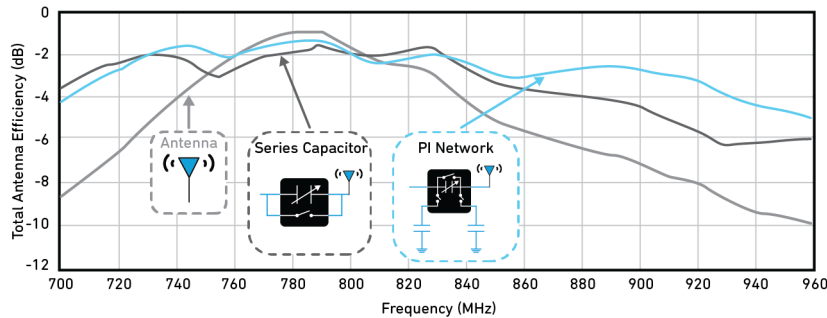

© Qorvo, Inc.

## Smart Tuning

Smart tuning using feedback from sensors, receive signal strength, forward/reflected power and antenna impedance can be used to set impedance tuning networks to the optimum state in order to maximize performance under different use case conditions.

For example, in a mobile phone, the primary low band transmit antenna is located at the bottom of the phone near the charging dock. The total antenna efficiency at the low band (700-960 MHz) is typically below 50%, and can fall below 25% due to changes in antenna impedance when a charging cable is connected to the phone, or when the phone is being held in gaming mode (landscape) with both hands.

In these use case conditions, the shift in antenna response can be corrected using a smart tunable impedance matching network.

Some use case conditions can be detected using sensors inside the phone. For example, the accelerometer in a phone can identify the orientation of the screen. It is easy to detect when a charging cable is connected to the phone. The received signal strength can also be used to estimate the use case condition.

In a mobile phone, the tuner state is typically determined based on the operating band or frequency range that is currently in use. However, feedback from sensors can be used to set the tuning state to a different value to increase performance. For example, the capacitance value of a series tunable capacitor can be set to different values depending on the use case condition, as shown in Figure 21.

Figure 21: Capacitance required with phone in each mode of operation.

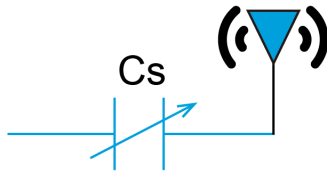

Free space	Landscape mode	Charging cable	Talking on phone
0.75 pF	1 pF	0.5 pF	1.25 pF



© Qorvo, Inc.

Not all use case conditions can be identified with sensors, and there is always the possibility that the sensors are not accurately sensing specific conditions. Therefore, a feedback mechanism can be used to detect the antenna impedance as well as the forward and reflected signal power. This information is then used to set the tuner to the optimum state, thus covering a wide range of use case conditions and greatly minimizing the possibility of error.

## Conclusion

Impedance tuners are a key solution for overcoming antenna efficiency problems caused by the growing RF complexity in mobile devices. By increasing the RF power transferred between the RFFE and antenna, impedance tuners help smartphone manufacturers maximize performance for different use cases and frequency bands. As a result, manufacturers are incorporating impedance tuners into a growing number of mobile devices, especially as they transition to 5G.