



Articles To Make You Smarter From 5G to the IoT

A collection of the most compelling articles
on all things RF from Qorvo.com.

qorvo[®]
all around you

Feed Your Genius

Check out our design hub



MatchCalc™ RF Design Calculator

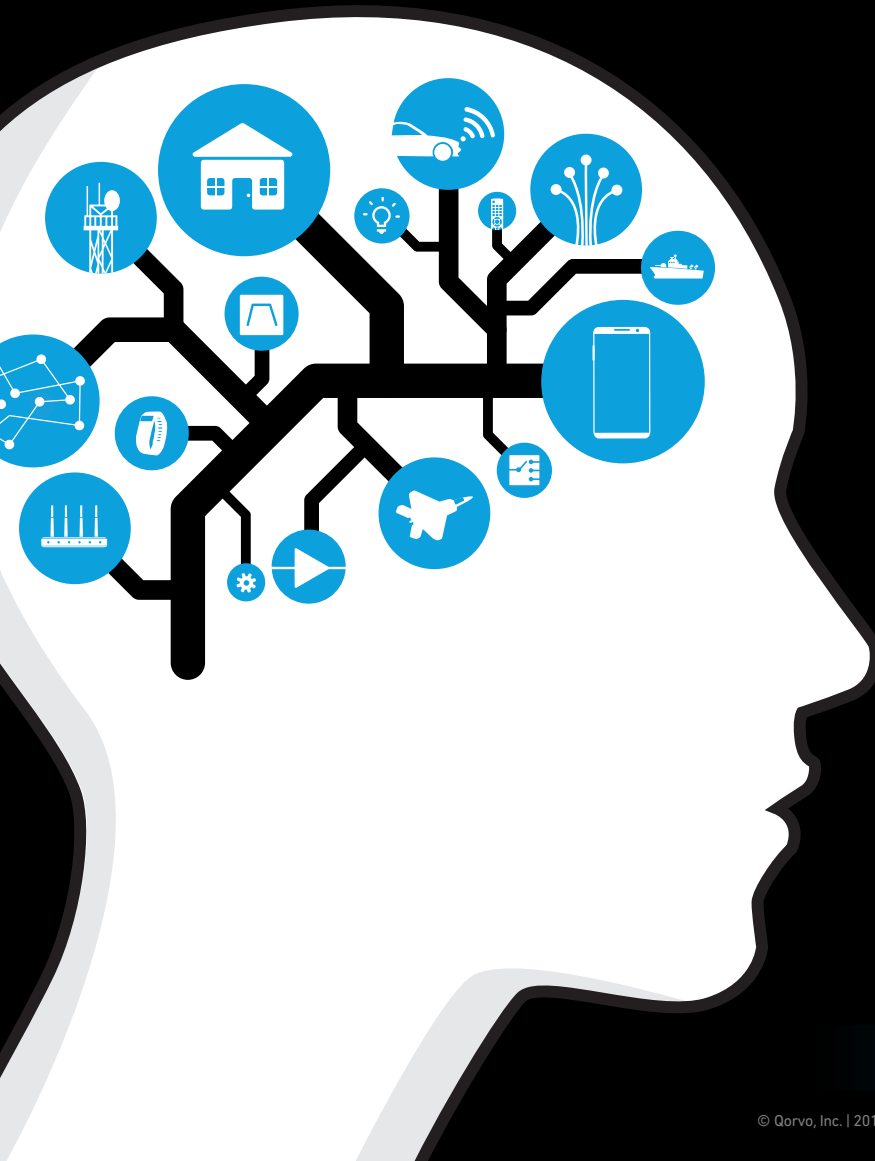
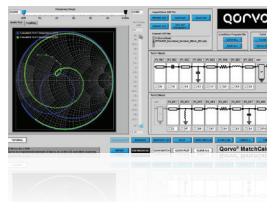









Qorvo connects the world. From the IoT and smartphones to defense and everything in between. Explore our resources to find out how.

Downloadable Software



GaN Models

Modelithics® Qorvo GaN Library

-  Videos
-  eBooks
-  Whitepapers
-  Blogs
-  Design Tools
-  Brochures
-  Block Diagrams
-  Published Articles

QORVO

www.qorvo.com/designhub

5G and the Need for Speed



Introduction

Tesla's "Maximum Plaid" speed mode rockets its new Roadster from 0-60 in 1.9 seconds. If you think that's fast, go ahead and Google "5G."

5G is plaid for cellular networking – a next-generation mobile network that promises not only ten-times the available spectrum, for ten-times the download speeds, but across ten-times the devices and with a fraction of the latency.

The move from 1Gbps to 10Gbps speeds will support bandwidth-intensive applications like high-definition video and virtual reality, and near real-time connections will enable ultra-low latency applications like autonomous cars, remote surgery and specialized applications within the Internet of Things (IoT).

5G is impressive, but – spoiler alert – it isn't entirely new. The road to 5G runs through 4G wireless infrastructure, and improvements to 4G technologies like carrier aggregation (CA), small cells, massive multiple-input and multiple-output (MIMO) and beamforming will satisfy our need for 5G speed.

Carrier Aggregation

IDC forecasts that by 2025 the global datasphere will grow to 163 zettabytes. For the folks at home, that's 163 trillion gigabytes. Much of this will be mobile data, transmitted in real-time between phones and IoT devices.

As demand for mobile data increases, mobile carriers and manufacturers face a conundrum. There is a finite amount of radio frequency spectrum at any given time, but they must increase capacity and offer faster data speeds to meet user demand. The key is squeezing the most out of existing RF spectrum – and for that, there's CA.

CA is a technique that combines multiple carrier signals – or "channels" – to increase network performance. As consumers, we love CA, because we hate buffering. CA accelerates downloads and uploads, allowing cellular networks to move more data, faster.

Gamers and Instagram influencers, rejoice!

CA is already used to combine multiple 4G LTE-advanced frequency bands. As we approach 5G, cellular service providers will seek to squeeze even more bandwidth out of existing spectrum by combining as many as five channels.



Small Cell

Cellular base stations connected to cell towers carry signals over the river and through the woods to the dinner table at grandma's house. Because 5G builds on the 4G foundation, carriers can simply upgrade these towers to support higher 5G frequencies, like 28 GHz and 39 GHz.

There's a catch. These millimeter wave (mmWave) frequencies cannot penetrate walls or buildings. Thick walls, frame and cement impede mmWave signals, turning downtown into a dead zone. Plus, being far from a base station is a drag – on your battery life, that is.

This is where small cells come in: mini base stations that act as a relay team to transmit around objects, improve battery life and deliver an extra boost in densely populated areas, like sports stadiums, airports and urban centers. Small cells also help service providers avoid satellite dish syndrome, eliminating expensive rooftop systems while extending coverage.

Massive MIMO

I say, "massive," you say, "tiny antennas!"

Maybe not, unless you're an RF engineer familiar with massive MIMO. Massive MIMO is a fancy term for equipping cell towers with more antennas to extend network capacity without requiring more spectrum. Sound familiar?

We're not talking an antenna or two. Massive MIMO systems have ten times more antennas than traditional MIMO systems to connect to multiple devices at once. At Mobile World Congress, Nokia and Sprint demonstrated massive MIMO technology with 64 antennas each for uplink and downlink. According to CIO, this increased capacity by as much as eight times for downloads and as much as five times for uploads.

Massive MIMO has been called the backbone of 5G. Without it, operators could not handle the bandwidth and capacity requirements for the next-generation network. Tiny antennas, massive impact.

**Tiny antennas,
massive impact.**

Beamforming

Tiny antennas also cause massive interference problems.

Enter beamforming, and no that's not a teleporter. Beamforming technology drives signals directly to the point of use. We see this with many new Wi-Fi routers, where beamforming is used to focus the Wi-Fi signal and improve signal strength and range.

Beamforming is used similarly in base stations. With this technology, base station antennas focus data streams as they leave the tower, improving speed and reliability for consumer devices.

So, whether you're video chatting across the country or sharing cat memes across the table, take a moment to thank these 4G technologies for the speed.

Oh, and buckle your seatbelts. We're going to plaid.

**Beamforming
technology drives
signals directly to
the point of use.**

How Carrier Networks Will Enable 5G

Active antenna systems (AAS), beamforming, beam steering, fixed wireless access: the transition to 5G is bringing new terminology and technologies to life in the commercial space. At its heart, 5G begins with the carrier network and how it enables these next-generation technologies. This article explains some of the key RF communication technologies that will enable 5G base stations and networks.

This article is an excerpt from Chapter 4 of our e-book, 5G RF For Dummies®.

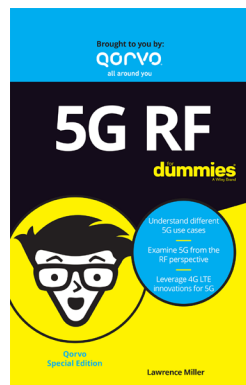

5G Begins With The Carrier Network

5G networks must handle many functions that require different active antenna systems to meet the challenges of enhanced mobile broadband (eMBB), massive machine-type communications (mMTC), and ultra reliable low-latency communications (uRLLC).

One of the first major applications will be active antenna systems in the mmWave bands, providing FWA. FWA provides an initial stepping stone toward 5G in the mmWave bands. Carriers and infrastructure manufacturers alike have been conducting trials and plan to offer this service as a more scalable and economical way to deliver broadband. Although this service is for nomadic and fixed users, it is being designed with true mobility in mind. This allows carriers to get their feet wet in new mmWave technologies – such as phased array antennas and hybrid beamforming – that will be the basis of mobile 5G.

A very recent twist in 3GPP standards definition – the addition of an accelerated path, called non-standalone (NSA) 5G – as a cost-effective way to bring early 5G benefits to market without the expense of building out the 5G network core needed for standalone (SA) 5G. NSA accomplishes this by using an existing 4G 3GPP band as an LTE anchor in the control plane.

AAS/FD-MIMO

The AAS is an advanced base station platform with optimized cost, structure, and performance. 4G release 12 enhancements significantly impacted how enhanced NodeB (eNodeB) radios are designed. Release 12 items included new combinations of carrier aggregation, spatial multiplexing enhancements with downlink MIMO (multiple input/multiple output), and RF requirements needed in AAS. This first figure summarizes portions of the release 12 items with respective features and benefits.

The active antenna system (AAS) is an advanced base station platform.

Evolution of LTE Advanced eNodeB Radio Antennas

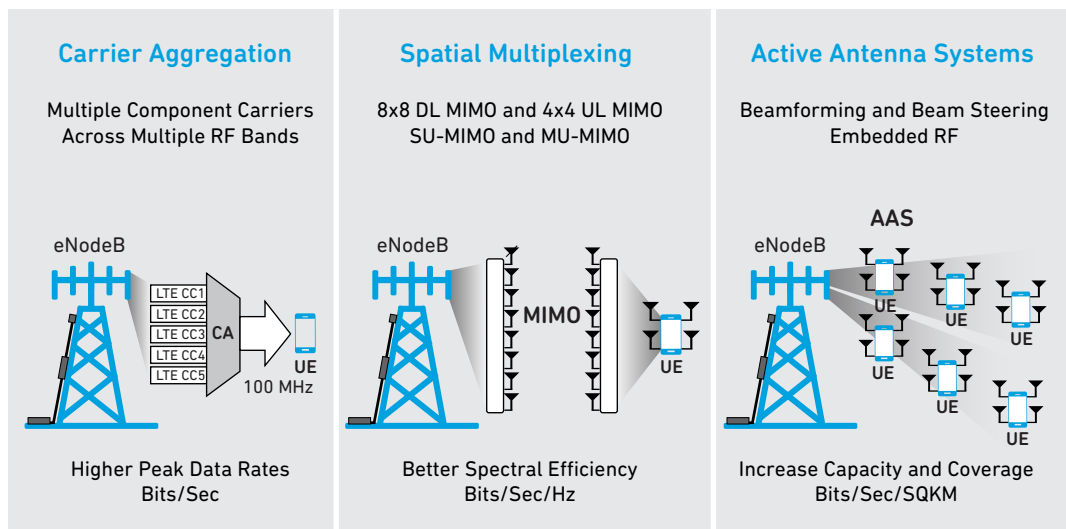

MIMO technology uses multiple antennas installed at both the source (transmitter) and destination (receiver), to improve capacity and efficiency. As shown in the previous figure, more antennas equals more data stream layers. This results in a bigger data pipe to a single user or multiple data pipes to separate users, also known as multi-user (MU) MIMO.

Massive MIMO takes MIMO to the next level. Today's MIMO deployments typically consist of up to eight antennas on the base station and one or two antennas on the receiver. This allows the base station to simultaneously transmit eight streams to eight different users or double down and send two streams to four users. **Massive MIMO scales to dozens or hundreds – theoretically thousands – of antennas, providing capabilities and benefits that include the following:**

- Vastly improved capacity and reliability
- Higher data rates and lower latency
- Better connections (especially with the challenging higher frequencies to be used for 5G)
- Less intercell interference
- Greater efficiency and better signal coverage enabled by beamforming

The figure to the right illustrates how an AAS/full-dimension (FD) MIMO base station can direct beams in both the horizontal and vertical directions.

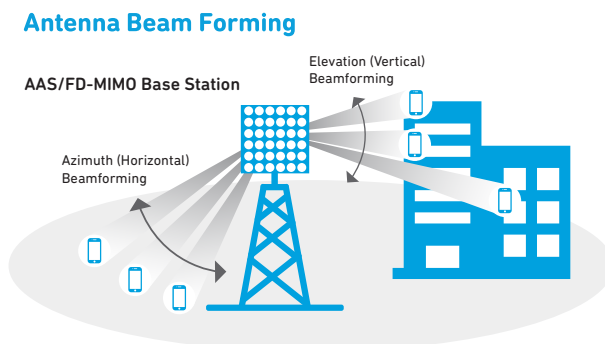

This operation dynamically points the antenna pattern on a per-user basis, providing a better link and higher capacity to that user. In turn, this allows him to offload his traffic and free the radio resources more quickly, which can then be used by others, resulting in a net increase in aggregate capacity for the entire cell.

5G End-to-End Fixed Wireless Access (FWA) Networking Using Beam Steering

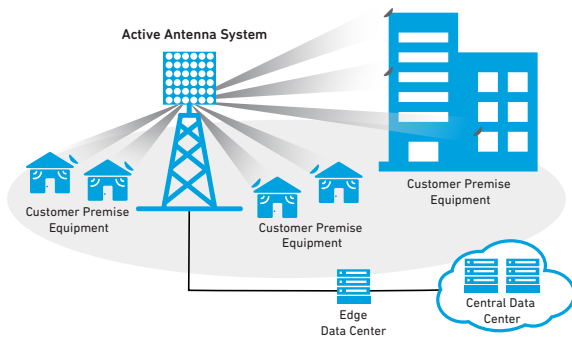

One of the obvious advantages of 5G FWA is its ability to support very high peak data rates without requiring dedicated fixed facilities for each individual user. To enable higher peak data rates and greater system capacity, FWA radios will make use of new higher frequency bands from 24 GHz up to 42 GHz and potentially even higher.

Using larger antenna arrays provides additional beamforming to overcome more severe propagation challenges encountered at mmWave frequency ranges. These arrays can have hundreds of elements but due to the short wavelength are extremely compact. For example, a 64-element antenna array at 30 GHz is only 40 mm x 40 mm. Large arrays provide very focused beams that can be redirected in less than a micro-second. In addition, the large phased array can act as a single array or as multiple independent subarrays with unique beams directed to service multiple user terminals simultaneously on the same frequency resource.

The figure to the left illustrates how AAS uses beam steering to provide end-to-end fixed wireless access (FWA) connectivity to customer premise equipment (CPE) located in commercial buildings and residential homes.

Active Antenna System and Beam Steering RFFE (2x2 LTE RF Front End)

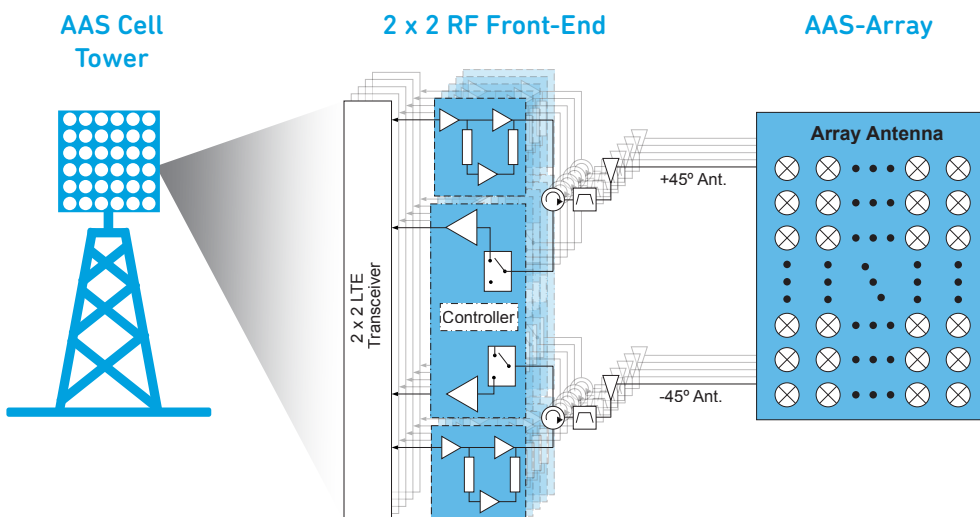

Designing for 802.11ax Wi-Fi: Common Challenges and Tips to Overcome Them

Let's examine some of the challenges that RF engineers will face when designing for 802.11ax and some tips on how to overcome them.

Some Background: 5 OFDMA PPDU Formats For 802.11ax

When developing Wi-Fi access points, designers must consider many wireless technology standards:

But first, let's look at the foundational signal structure for 802.11ax – the physical layer protocol data units that Wi-Fi clients and devices use to communicate.

802.11ax uses five formats for its OFDMA PPDU:

- Single user (HE-SU): for transmitting data from a single user
- Multi user (HE-MU): for transmitting data to one or more users that isn't in response to a trigger frame
- Outdoor (HE-xSU): for outdoor transmission for a single user, this format is new in 802.11ax
- Trigger response (HE-TRIG): for transmitting data in response to a trigger frame, used to coordinate uplink MU-MIMO or uplink OFDMA transmissions with the access point
- Downlink channel sounding (HE-NDP): for beamforming and downlink channel sounding

See the image at the end of this section for details of the frame packets and fields within each PPDU format.

Wait Or Sleep Times: What Are The Challenges For The RF Front End?

One thing 802.11ax adds is target wait time (TWT) – also known as sleep times – which allows a device to stay in a sleep state longer before transmitting data. This resource scheduling improves battery life and means a better experience for a consumer.

TWT in 802.11ax

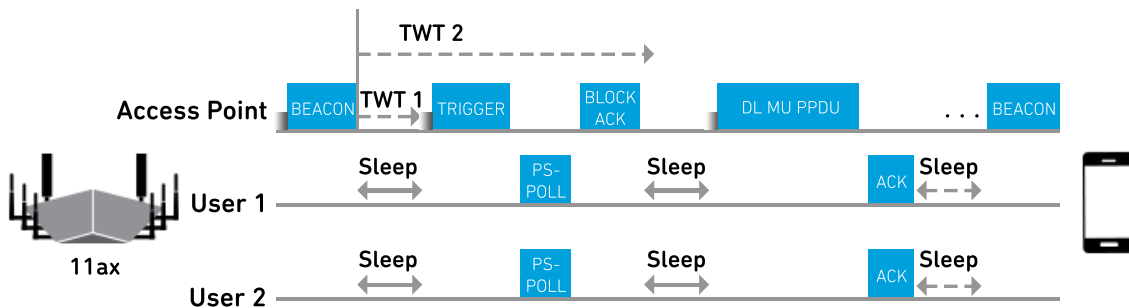

Credit: NI.com

However, latency in turn-on mode could be an underlying challenge. TWT also brings the following:

- High susceptibility to frequency and clock offsets in OFDMA. Unlike LTE base station technologies, 802.11ax doesn't have a synchronized clock signal. As a result, devices will rely on the access point to keep all the devices on the network synchronized. Additionally, 11ax uses longer OFDM symbols than 11ac, which means more data comes through. In short, the access point will have to work harder – and be more accurate – than in the past.
- Flatness maintained over a longer time period. The specs we've received from some of our chipset partners show that the initial power amplifier (PA) turn-on time has not changed in 802.11ax; it's still 200-400 nanoseconds. However, the gain flatness has been extended, guaranteeing the front-end module (FEM) has no gain expansion or gain droop for the duration of the packet.

Indoor vs. Outdoor Wi-Fi: What Are the Similarities And Differences?

For 802.11ax to work across all environments, both indoor Wi-Fi and outdoor base stations or small cells will be required.

The front-end development is very similar for indoor and outdoor environments. The coexistence strategy – out-of-band rejection, harmonic filtering and frequency range – is similar.

The main differences between indoor and outdoor environments include:

- A new data packet structure for outdoor. As we mentioned earlier, 802.11ax adds an entirely new data packet format for outdoor Wi-Fi, the HE-xSU PPDU format (shown in the PPDU figure at the end of this blog post). The extended range of the outdoor PPDU format allows the Wi-Fi signal to travel longer distances, as is typical for an outdoor Wi-Fi environment.
- Power levels and the resulting thermal considerations. Although some customer premises equipment (CPE) applications have similar power targets as mobile, there is also a high-power category, which means thermal management is even more important.

Designing For Tighter System Requirements In 802.11ax

The modulation scheme used in 802.11ax, 1024 QAM, quadruples the wireless speeds. But it also means the system becomes more sensitive to internal and external impairments.

Here are some of the design challenges that engineers should be aware of:

- Tighter linearity specs for the PA. The tighter constellation density in 1024 QAM drives the PA linearity requirement to approximately -47 dB EVM in 802.11ax. (However, there are efforts to relax the system EVM requirement per IEEE doc 11-17-1350.) Also, don't forget to assess the test systems required to measure these EVM levels for FEMs/iFEMs.
- Low noise amplifiers (LNAs) must have a lower NF. Earlier reference designs required LNAs to have a noise figure (NF) target range of 2.5-3 dB. In 802.11ax, system sensitivity targets drive new LNA targets of 1.5-1.8 dB NF.
- Gain expansion/droop. Ten years ago, the gain imbalance target was 1 dB. Now it has decreased to 0.3-0.5 dB. As shown in the following figure, gain and phase imbalance are being pushed to the lower left to attain -47 dB EVM.
- The overall system margin. From a design perspective, the target PA specification is -47 dB EVM, but the actual system spec is -35 dB EVM. Chipset partners will typically drive for system margin.

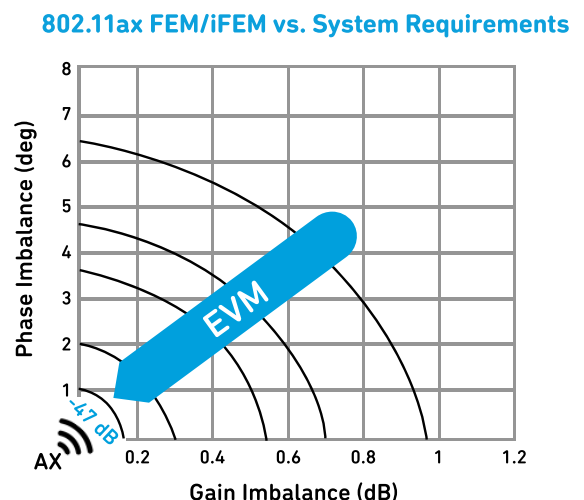

To address all these design challenges, engineers and marketing can consider the following:

- Increase current consumption to meet EVM targets.** A system will typically achieve better EVM if you increase I_{cc} , but it will also lower the power-added efficiency (PAE). To achieve a decent PAE and linearity tradeoff, you need to optimize these major focus areas:
 - Load line
 - Interstage matching
 - Bias circuit design
 - Digital predistortion (DPD)
 - Envelope tracking (ET)
- Design assumptions:** Ask if the device needs to be best-in-class for the premium tier or serve mass tier. The answer really depends on the market, because requirements vary by customer and application. Early adopters and flagship premium products may push for best-in-class performance (-47 dB EVM). In contrast, if the product is for mass tier or the low-cost market, devices probably won't be required to support 802.11ax for a few years after initial adoption in the premium tier.

A Final Thought: Designing For A Standard That's Still In Flux

Above all, remember that the 802.11ax spec is still being defined, and you should work with your applications team to maximize your product designs for the emerging standard. Qorvo is committed to helping customers and providing design expertise as this Wi-Fi standard takes shape.

You can also read these resources from some of our hardware partners to dive into technical details of this developing technology.

OFDMA PDU Formats

5 Formats for 802.11ax (High-Efficiency Wireless)

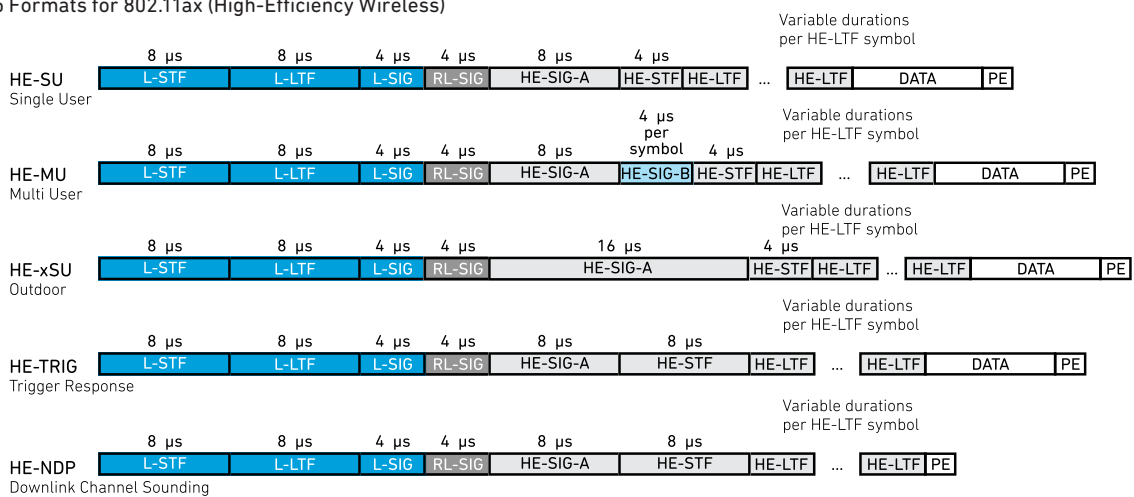

Field	Description
L-STF	Legacy Short Training Field
L-LTF	Legacy Long Training Field
L-SIG	Legacy Signal Field
RL-SIG	Repeated Legacy Signal Field
HE-SIG-A	HE Signal A Field
HE-SIG-B	HE Signal B Field
HE-STF	HE Short Training Field
HE-LTF	HE Long Training Field
DATA	Data
PE	Packet Extension Field
GI	Guard Interval
LTS	Legacy Training Sequence

Resolving Interference in a Crowded Wi-Fi Environment Using BAW Filters

There are any number of strategies that consumers can try to fix interference problems with Wi-Fi in their homes – moving the router, reconnecting the device to their Wi-Fi network, power cycling the modem... and calling their service provider when nothing works and they don't know what else to try. But as an RF engineer, how can you design a Wi-Fi access point that addresses the biggest interference issues from the outset?

This blog post examines the following factors that can impact Wi-Fi interference:

- The need to support multiple wireless standards
- Different types of interference
- Why band edges matter
- The importance of high-performance bandedge and coexistence BAW filters



One Access Point, Many Standards

When developing Wi-Fi access points, designers must consider many wireless technology standards:

- Standards that operate at short and mid coverage ranges, such as Bluetooth, Zigbee and Z-Wave
- Standards that operate at higher power levels and short and long ranges, including Wi-Fi, 3G/4G LTE and 5G

Many of these standards can interfere with each other, leading to connectivity problems for users.

And then there's unlicensed spectrum to contend with. Licensed and unlicensed networks are becoming more important factors as constrained wireless communications offload data to continually expand capacity. Also, the new Internet of Things (IoT) realm draws heavily on this unlicensed spectrum.

The challenge is to keep all these licensed and unlicensed bands and multiple protocols working in conjunction with each other without interference difficulties.

Different Types Of Interference: From In-Device To LTE And Bluetooth

Interference can occur within a device or between devices, including between wireless carrier signals or between wireless standards. The most common interference scenario is Bluetooth and LTE with Wi-Fi because these technologies are so widespread. Let's look at some of these in more detail.

Characteristics of Wireless Technology

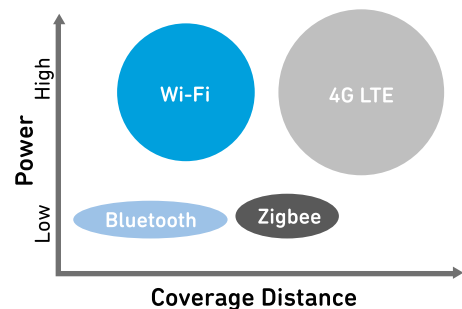

In-Device and External Interference

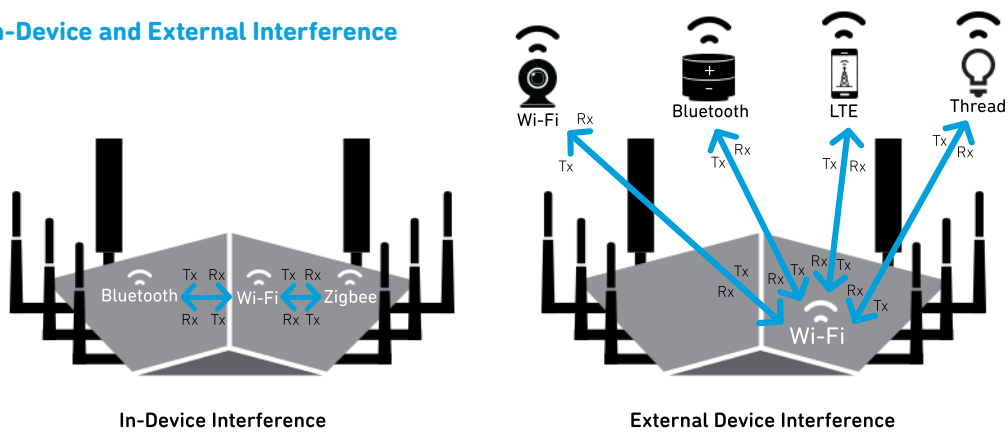

- In-device coexistence:** For in-device coexistence, the system’s multiple antenna architectures can interfere with each other. As a result, the coupling between the affected antennas (antenna isolation) is compromised. The foreign transmit (Tx) signal increases the noise power at the affected receiver, which has a negative impact on the signal-to-noise ratio. The receive (Rx) sensitivity decreases, which causes what engineers call “desensitization.”

Desensitization is a degradation of the sensitivity of the receiver due to external noise sources, and results in dropped or interrupted wireless connections. It isn’t a new problem – early radios encountered receiver sensitivity when other components became active – but now it’s particularly troublesome for today’s wireless technologies, including smartphones, Wi-Fi routers, Bluetooth speakers and other devices.

The primary “desense” scenarios are:

- Two radio systems occupy bordering frequencies, and carrier leakage occurs
 - The harmonics of one transmitter fall on the carrier frequencies used by another system
 - Two radio systems share the same frequencies
- LTE and Wi-Fi:** As shown in the below figure, several LTE bands – Bands 40, 7 and 41 – are very close to the Wi-Fi band channels. Leakage into the adjacent Wi-Fi radio band is very probable at both the high and low end of the 2.4 GHz band. Without proper system design, the cellular and Wi-Fi channels 1 and 11 can interfere with each other’s transmissions and receive capability.

Spectrum Example of Asia and EMEA

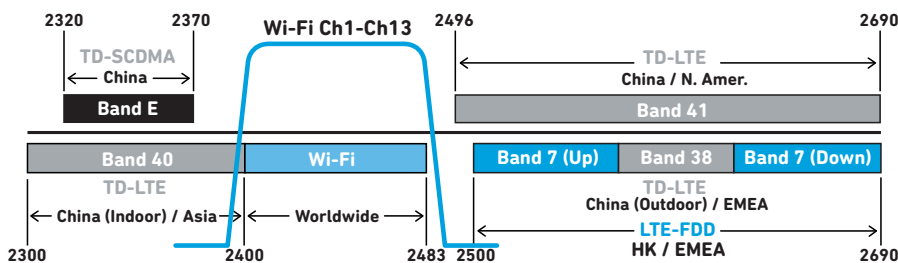

- Bluetooth and Wi-Fi:** Bluetooth and Wi-Fi transmit in different ways using differing protocols, but they operate in the same frequency ranges, as shown in the following figure. As a result, when Wi-Fi operates in the 2.4 GHz band, Wi-Fi and Bluetooth transmissions can interfere with each other. Because Bluetooth and Wi-Fi radios often operate in the same physical area (such as inside an access point), interference between these two standards can impact the performance and reliability of both wireless interfaces.

ISM, Wi-Fi & Bluetooth Channel Frequencies

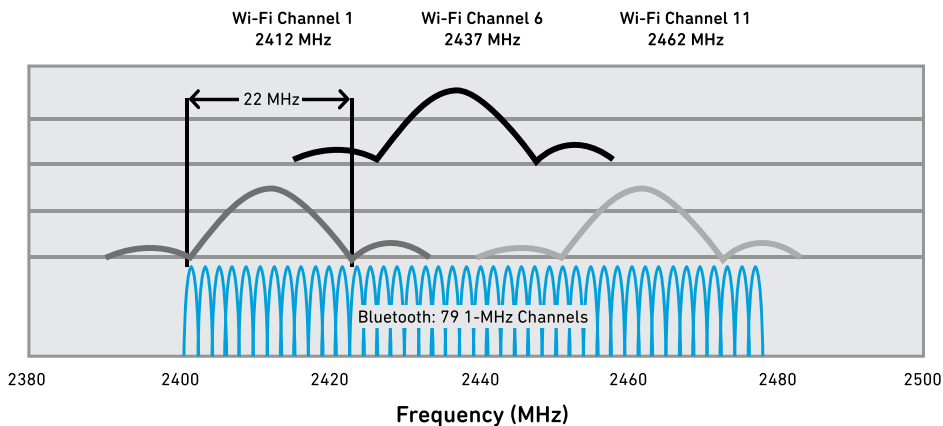

Why Bandedges Matter For Wi-Fi Coexistence

One way federal governments have tried to help consumers is by regulating the emissions and spectrum of many electronic devices and requiring consumer products to undergo compliance testing.

In the United States, the federal communications commission (FCC) requires that most RF devices undergo testing to demonstrate compliance to FCC rules. They enforce strict bandedges by requiring steep skirts on the lower and upper Wi-Fi frequencies, to help with coexistence with neighboring spectrum.

Spectrum Example of Wi-Fi and Bandedge

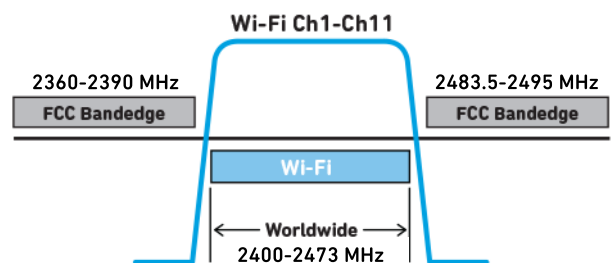

There are two ways for Wi-Fi access points to meet this FCC requirement:

- Back off the power level on Wi-Fi channel 1 and 11, because they're at the edge of the Wi-Fi spectrum
- Use filters with very steep bandedges

Design Tips To Overcome Interference Challenges: Use High-Q BAW Filters

Our approach is to use high-performance coexistence and bandedge filters, to allow Wi-Fi transmitters to operate close to the upper and lower FCC bandedges.

Customers have had success using high-Q bulk acoustic wave (BAW) bandpass filters, which offer many advantages:

- **Extremely steep skirts** that simultaneously exhibit low loss in the Wi-Fi band and high rejection in the band edge and adjacent LTE/TD-LTE bands
- **Significant size reductions**, which aid designers in creating smaller, more attractive end-user devices for homes and office environments
- **Resolves coexistence of Wi-Fi and LTE signals** within the same device or near one another
- **Unique power handling capabilities**, allowing for implementation into high-performance, high-power access points and small cell base stations

These filters address the stringent thermal challenges of multi-user multiple-input/multiple-output (MU-MIMO) systems, without compromising harmonic compliance and emissions performance. This is critical to achieving reliable coverage across the full allocated spectrum.

But why do high-Q BAW filters make such a difference for FCC band edges?

#1: BAW devices have lower insertion loss, steeper band edges and better temperature stability than SAW technology at Wi-Fi frequencies

As you move into higher bandwidths like Wi-Fi, surface acoustic wave (SAW) devices can suffer from higher insertion losses than BAW due to radiation of acoustic energy into the bulk of the substrate. As shown in the following figure, as you move up (to the right) in frequency, you can see high-Q BAW is a good option for filter designs due to this bulk radiation loss effect. Also, BAW maintains the steep skirts required for FCC band edges; SAW can't meet the performance requirements at these higher frequencies.

BAW also has better temperature stability than other technologies, which gives it an advantage during FCC certification tests. Most Wi-Fi designs are created at room temperature (20-25°C) on a bench, but the system in its application environment can actually operate around 60-80°C. Insertion loss increases as temperature increases, and failing to estimate for this can cause issues during product certification. Using BAW reduces the shifts in insertion loss and makes certification test results more predictable.

Learn more about BAW versus SAW in our free e-book, *RF Filter Technologies For Dummies® (Volume 1)*.

BAW Versus SAW Technology

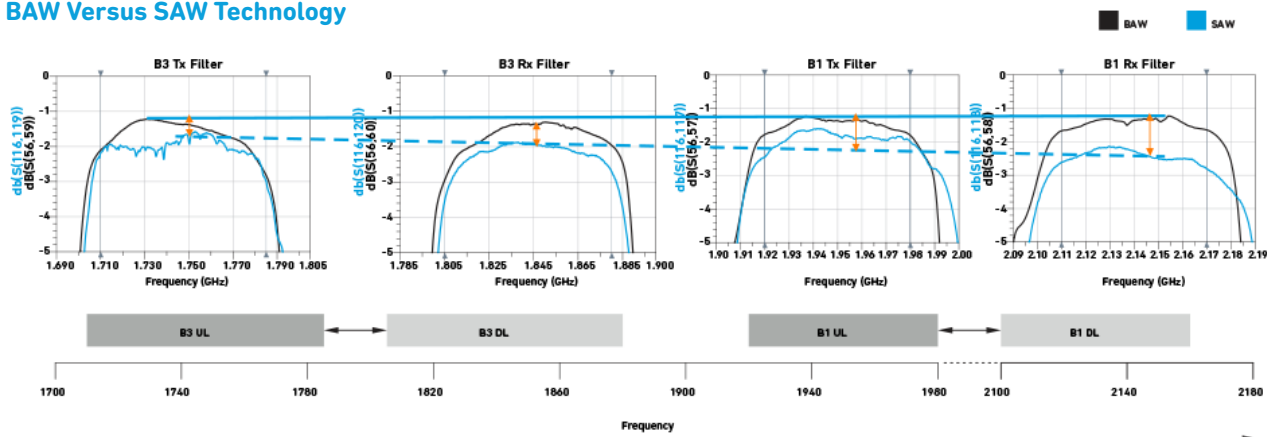

#2: BAW filtering can help engineers provide seamless transitioning between interfering bands

As shown in the following figure, the bandedge response is better using a filter than without it, and it allows designers to push the limit on RF front-end output power while meeting the FCC requirement for power spectral density. This means bandedge BAW filtering allows operators and manufacturers to deliver high-speed data and greater bandwidth by using spectrum that might be lost with no filtering.

FCC Restricted Bandedge With and Without BAW Filter

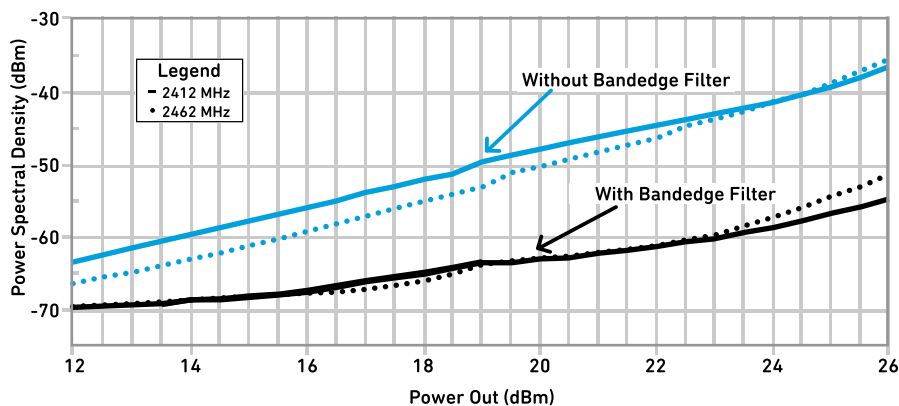

#3: High-Q BAW bandedge filters can extend the range in channel 1 and 11 by 2-3 times

Wi-Fi designers normally must set the entire unit power to whatever the lowest bandedge-compliant power is for all channels. So, if the compliant channel at channel 1 is 15 dBm but channel 6 can achieve 23 dBm, the designer settles the entire power control scheme to 15 dBm. Using bandedge filtering allows designers to set the power scheme to much higher powers, thus making it possible to use fewer RF chains to achieve their goals.

BAW bandedge filters can also exhibit power handling capabilities for transmitting up to 28 dBm. This can improve system performance by greater than 15 percent and enable 5G multi-MIMO with less co-channel interference.

CPE developers who don't use bandedge filtering have difficulty meeting FCC requirements on Wi-Fi band channels 1 and 11. In contrast, when high-Q BAW bandedge filters are used, it allows the CPE designer to keep the power level the same throughout all the channels (1 – 11).

To paint the picture, here's the difference in user experience with and without bandedge filters:

- Without bandedge filters:** Let's assume you're in a house with several individuals using Wi-Fi and mobile phones. You're on Wi-Fi using channel 5, streaming a football game and experiencing no buffering or interruption. But then new mobile users arrive in the house and begin to take over your channel 5 Wi-Fi space. The CPE unit adjusts and bounces you to channel 1 to free up more space on channel 5. If the Wi-Fi unit doesn't have bandedge filters (as in the block diagram on the left), your Wi-Fi strength and streaming degrade to the point where buffering occurs. Why? Because to meet the FCC requirement, the CPE unit must back off its power in channel 1 so it doesn't interfere with adjacent cellular bands.

Wi-Fi/LTE System Models (With/Without Bandedge Filters)

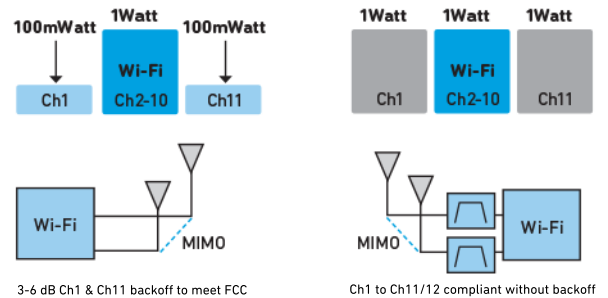

- With bandedge filters:** However, if the CPE unit had been designed with bandedge filters (as shown in the block diagram on the right), channel 1 and 11 would not be compromised and the power level would not require backoff. You can watch your streamed football game without any buffering.



Go In Depth: How Qorvo Wi-Fi Solutions Can Help Solve Interference Challenges

In a connected world with more and more devices and wireless standards, coexistence and interference issues will not go away. To make use of every bit of spectrum available, Wi-Fi designs with high-Q BAW filters can improve the performance of Wi-Fi access points.

How Spatial Combining Works

New Levels of Power for TWTA Replacements

Replacing legacy systems with next-generation technology isn't always a one-to-one fix. This blog describes spatial combining, why it's important for sensitive equipment like electronic countermeasures (ECMs) and how it helps achieve the highest levels of power available.

Power In The Past



Cathode Ray Tube Television

Historically, vacuum tube amplifiers were used for all amplifiers, from audio frequency to RF and microwave, as well as for lighting and the displays for our television sets. Traveling wave tube amplifiers (TWTAs) have continued to provide high-power amplification at microwave frequencies over broad bandwidths.

But vacuum tubes, typically in the multi-kV range, have lower reliability than solid-state devices, with low-voltage power supplies, and over time, the supply of vacuum tubes and the expertise to manufacture them have decreased. As a result, most vacuum tubes have been replaced with solid-state alternatives, except in applications such as microwave ovens and electronic warfare (EW), which required vacuum tubes to generate the higher power levels necessary for equipment like ECM jamming transmitters.

But power combining techniques now make it possible to achieve these power levels with solid-state devices.

Spatial Combining: What It Is And Why It's Important

ECM systems comprise receivers, processors, displays and jamming transmitters. Only recently have solid-state solutions been able to meet the power and bandwidth requirements of ECM jamming transmitters, due to the advent of gallium nitride (GaN) power amplifier MMICs and low-loss, broadband combining techniques. However, a single GaN MMIC still has insufficient power for most ECM systems, which can have requirements of more than 100 watts from 1.5-7.5 GHz. Solid-state devices must combine multiple power amplifiers to reach the same power levels originally offered by TWTAs.

Spatial combining can create solid-state power amplifiers (SSPAs) in the following ranges of frequency and power – which all provide performance improvements when compared with TWTAs:

- 100 W to 1 kW, 1 GHz to 40 GHz covering up to a decade of bandwidth
- Reduced harmonic content in the output spectrum
- Less noise generated
- Increased linearity

Caution: Heat Dispersed For Best Operation

Thermal management is critical to get the best performance out of solid-state devices. For ECMs, we often work with different thermal environments on different platforms. Some systems could use a cooling fluid or air cooling with a fan.

Spatial combining provides the most efficient means of combining GaN MMICs, lowering the amount of heat dispersed. When we measure thermal performance, the efficiency of the total amplifier is the most important factor.

The efficiency of GaN MMICs combined with the efficiency of spatial combining yields the most efficient solid-state amplifier available. The more efficient the solid-state device, the lower the amount of heat that must be dissipated.

Also, when solid-state components operate cooler, their reliability is better so we want them to operate as cool as possible. Using good thermal conductors, like copper, and maximizing the available cross section are key for improving the thermals. However, there are trade-offs between the types of metals used and the weight of the equipment – it can't be too heavy for airborne platforms, for instance. So, there are other metals that can be used when making size, weight and power (SWaP) considerations.

How Is Spatium Being Used Today?

Qorvo's method of spatial combining is called Spatium®. With coaxial construction, Spatium provides an efficient, broadband and compact way of combining multiple MMICs in a single step. In fact, Spatium can typically combine 16 amplifiers in one step, with only 0.5 dB combining loss. In addition, Qorvo designed a thermal path on the back of the MMIC to the cooling plate, to help with thermal management. (See the figure below for a thermal simulation using Qorvo's Spatium QPB1006.)

Here's how Spatium MMICs can be used in different applications:

- **Electronic warfare:** Spatium can be used in airborne, land, or naval ECM equipment, typically in the transmitters for the antennas.
- **Satcom:** Spatium is used in Ka-band satellite earth stations that operate at 100 W and 27-31 GHz, covering both military and commercial bands. It is used in ground stations on the transmitter side at the antenna hub in block up-converters (BUCs).
- **Testing:** Spatium can be used in high-power microwave signal generators or as a load pull on high-power devices, during input impedance to figure out how devices will respond. In these environments, a higher-power amplifier is needed to fully characterize these devices.

Three new Spatium products are intended for designing new EW equipment, operate within 2-18 GHz, and could replace legacy tubes. The products can also be used in test equipment where a high-power stimulus is needed. Less noise and more linearity than legacy TWTAs mean measurements taken with Spatium will have greater fidelity.

Spatial combining offers the ability to deliver hundreds of watts over broad bandwidths and can be specially designed, in many cases, for a new box or to fill an existing TWTa space.

This is the first time there's been this type of power, bandwidth and efficiency available for solid-state devices. It offers a viable option for 20- to 30-year-old platforms (aircraft, ship, etc.) with non-fixable vacuum tubes; they can now be replaced with reliable, solid-state equipment.

Example of Thermal Simulation Using Qorvo's Spatium QPB1006: Cooler performance, better reliability

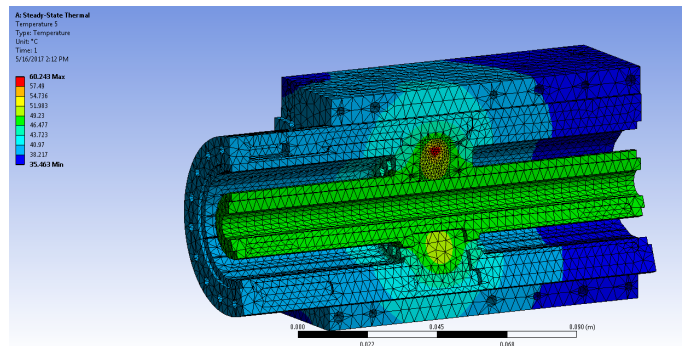

Top Trends and Overcoming Design Challenges in Small Cells

What Are Some Of The Latest Trends Related To Small Cells?

- **LTE for usage in unlicensed bands:** Also known as LTE-U and licensed assisted access (LAA), unlicensed spectrum is starting to be implemented in small cell base stations. This unlicensed band access overlays LTE over the Wi-Fi band and provides carriers with another pipeline where they can control and guarantee quality of service (QoS).
- **Increased number of bands per system:** A couple of years ago, a lot of small cell base stations were just for single band. Many are now dual band, and moving forward in the next year or two, customers are developing and implementing triple-band systems. This will increase the system-level requirements for small cell solutions, both in terms of the number of components required and the complexity of the overall system design.
- **Customers designing with more efficient systems:** Systems targeted for shipment later this year are implementing linearization, which requires power amplifiers that are much more efficient than they are today. Today, systems are designed where the power amplifiers typically operate in backed-off mode, which means that the system just works without worrying how the PA performs. Linearization uses feedback so that the signal gets “cleaned up” by the baseband chipset and allows PAs to operate with much higher efficiency, translating into lower power consumption for the system.
- **Continued growth:** The small cell market has been emerging for a while, but over the past two years we have seen significant growth, at 50% year over year. Multiple analysts such as IHS Technology and Mobile Experts expect that small cell deployments will total more than 1 million small cell base stations for 2017.

What Are Common Or New Challenges Customers Have When Designing For Small Cell Applications?

- **Increasing number of bands per system:** Customers historically are designing these small cell systems for MIMO applications (multiple input/multiple output), which typically have 2 transmitters and 2 receivers per frequency band. As base stations incorporate multiple channels, it means more components – for instance, a three-band system would need six separate PAs (2 transmitters x 3 bands = 6 PAs) – which adds complexity, size and power consumption. Customers need the systems to be easy to design, easy to use (i.e., internally matched components), and efficient.
- **Ensuring good isolation and band separation for the transmit/receive channels,** specifically for Band 3 (1.8 GHz). The band separation is only 20 MHz, which requires very high isolation out of the duplexer.



How Does Qorvo Help Our Customers Solve These Design Challenges?

Qorvo has significantly expanded our portfolio of small cell filters and PAs, targeting products for specific frequency bands. Our customers have seen some of the following key benefits:

- **Filters for small cells:** Qorvo's BAW technology delivers high isolation and performance, particularly in our duplexers. Our small cell duplexers provide very good passive intermodulation (PIM) by reducing nonlinearities that may be introduced in the duplexer – which our customers have said is very important.
- **Small cell power amplifiers:** Qorvo PAs are internally matched and designed to provide temperature compensation inside the circuitry. This means our PAs are effectively plug and play and easy to use, which allows customers to easily design their system.

Qorvo has a complete small cell portfolio and is the only supplier to provide the entire RF front end, including LNAs, PAs, filters/duplexers and switches. All of our small cell products provide:

- High linearity
- High isolation
- Low power consumption
- Low link budget

Small Cells FDD

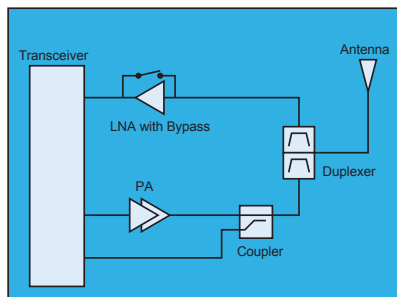

Small Cells TDD

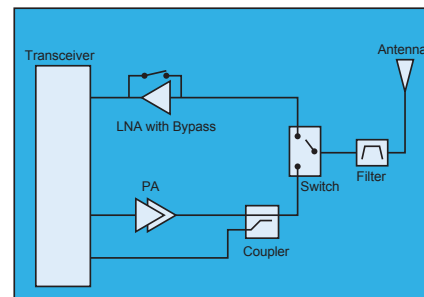

Qorvo 5G Product Highlights



QPF4001

GaN single channel FEM

- Frequency: 28 GHz
- Package dimensions: 5x4 mm



QPF4002

GaN dual channel FEM

- Frequency: 28 GHz
- Package dimensions: 5x8 mm



QPF4006

GaN single channel FEM

- Frequency range: 37-40.5 GHz
- Package dimensions: 4.5x4x1.8 mm



QPF4005

GaN dual channel FEM

- Frequency range: 37-40.5 GHz
- Package dimensions: 4.5x6x1.8 mm



QPQ6108

SAW duplexer

- High input power: 29 dBm on DL
- Package dimensions: 2.5x2 mm



QPA9908

High-efficiency PA

- 5V, 4W
- Package dimensions: 5x5 mm



QPA9903

High-efficiency PA

- 5V, 4W
- Package dimensions: 5x5 mm



QPA9940

High-efficiency PA

- 5V, 4W
- Package dimensions: 5x5 mm



QPA9942

High-efficiency PA

- 5V, 4W
- Package dimensions: 5x5 mm



QPA9120

Wideband driver amplifier

- Frequency range: 1.8-5 GHz
- Package dimensions: 3x3 mm



QPB9329

Dual-channel switch LNA module

- Frequency range: 3.8-5 GHz
- Package dimensions: 7x7 mm



QPL9503

LNA

- Frequency range: 1-6 GHz
- Package dimensions: 2x2 mm

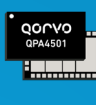

QPA4501

GaN PA module

- Frequency range: 4.4-5 GHz
- Package dimensions: 6x10 mm



QPD0020

DC-4 GHz GaN power transistor

- 25W, 48V
- Package dimensions: 4x3 mm



QPD0030

DC-4 GHz GaN power transistor

- 45W, 48V
- Package dimensions: 4x3 mm



QPD0050

DC-3.6 GHz GaN transistor

- 75W, 48V
- Package dimensions: 7.2x6.6 mm

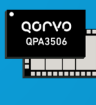

QPA3506

3.4-3.6 GHz GaN PA module

- 5W, 28V
- Package dimensions: 6x10 mm

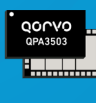

QPA3503

3.4-3.6 GHz GaN PA module

- 3W, 28V
- Package dimensions: 6x10 mm



QM19000

5G RFFE for wireless mobile devices

GTI Awards 2017
INNOVATIVE BREAKTHROUGH
IN MOBILE TECHNOLOGY

At Qorvo, we are developing RF solutions today,
for a better, more connected tomorrow.
Visit www.qorvo.com/5G for our latest products.